

Margaux Lespagnard

Renovation of residential post-war highrise:

UNDERSTANDING THE DESIGN PROCESS AND IMPACT OF REVERISBLE DESIGN TOOLS AND STRATEGIES

Master thesis submitted under the supervision of Dr. Eng.-Arch. Niels De Temmerman, co-supervision of Dr. Eng.-Arch. Waldo Galle in order to be awarded the Master's Degree of Science in Architectural Engineering



ACKNOWLEDGEMENTS

First and foremost, I would like to thank my supervisor Niels De Temmerman for changing my view on architecture over the past five years and to spark my interest in the possibilities of adaptable building. His passion and enthusiasm generated the main motivation to write a dissertation on dynamic buildings.

I would profoundly like to thank Waldo Galle, my co-supervisor, for his guidance during the entire process, the encouraging discussions and invaluable input.

I am thankful as well for Camille Vandervaeren, Charlotte Cambier and Ineke Tavernier for providing me constructive feedback and guidance throughout this research.

My gratitude goes to Jan Opdekamp, Ruben Janssens, Lourenço van Innis and Renaud Van Espen for their time and transparency and their introduction to the design processes of state-of-the-art projects. The interaction between theory and practice and the information they provided made this research possible.

Finally, I would like to thank family and friend for their eternal patience and support throughout the past five years. This is, to the extend valid for all the architecture engineering student with whom long nights in atelier were shared, the Bruface-program and the entire department of Architectural Engineering.

RENOVATION OF RESIDENTIAL POST-WAR HIGH-RISE: UNDERSTANDING THE DESIGN PROCESS AND IMPACT OF REVERSIBLE DESIGN TOOLS AND STRATEGIES

Margaux Lespagnard
Master of science in architectural engineering
2018-2019

Renovation, design process, design tools, high-rise

ABSTRACT

As the theoretical knowledge on circular building and reversible design grows, so does the interest of architects to be supported and encouraged to decrease the environmental impact of their building designs. A possible approach towards connecting theory to practice could be done using design tools and strategies.

This thesis attempts to decipher decisions, influencing factors and actors in the design process to improve the understanding on when the influence of a design tool could be most effective. First a timeline development method is established to analyse existing design processes. This method allows to detect how decisions are influenced or influence each other, but also when most research was directed towards a certain aspect of the design.

The timeline development method was tested on three case studies to evaluate its effectiveness. Three post-war high-rise renovations were chosen to answer to the current Belgian renovation tendencies. The information required to build the timelines was obtained through several interviews with the project architects. The application of the method on this case study provides information on trends and actors in the design processes. With this information, key phases are determined. They indicate when a certain reversible design tool or strategy would have the most significant impact on the design. The key phases are linked to design for change assessment tools. The potential of these key phases is then illustrated, by three examples where a tool is applied to a case study in the appointed key phase.

From research in this master thesis, it can be concluded that even though a design process is complex and different for each case, certain patterns can be concluded. The budget, legislations, being able to convince a client and the state of the existing building are the most influencing factors in the design process. The moment when information on existing building is received can have a great influence on the course of the design process. Design processes start with broad conceptual choices, mainly on the functions inside the building. This is when a tool that helps to define functional concepts could be most effective, for example, scenario planning. Thereafter, the decisions start to narrow down towards calculated choices on structural design and structural materials and technical concepts. A life cycle analysis could support architects to make decisions in this phase. In the last phase, before the construction, detailed designs for all elements and layers in the building are determined.

TABLE OF CONTENT

ACKNOWLEDGEMENTS	I
ABSTRACT	III
INTRODUCTION	I
1.1. SHIFTING APPROACHES TO THE BUILT ENVIRONMENT, FROM LINEAR TO CIRCULAR	I
Post-war high-rise	4
1.2. RESEARCH GOALS & AIMS	5
1.3. STATE OF AFFAIRS IN DESIGN RESEARCH: EXISTING ANALYSES OF DESIGN PROCESSES	6
Theories on design processes	6
Bottom-up design process analyses to understand how the environmental impact could be improved	8
Main actors in a design process	9
1.4. RESEARCH METHOD	11
Eindnoten	13
CASE STUDIES AND DESIGN FOR CHANGE	
ASSESSMENT TOOLS	15
2.1. INTRODUCTION OF THE CASE STUDIES	17
PETERBOS #9 – 51N4E + LACATON & VASSAL	18
51N4E	18
Lacaton & Vassal	18
Peterbos #9 and why it was chosen for this research	18
COSMOPOLITAN – BOGDAN & VAN BROECK	19
Bogdan & Van Broeck	19
The cosmopolitan and why it was chosen for this research	19
TOUR BRUNFAUT – A229 + DETHIER ARCHITECTS	20
A229	20
Dethier architects	20
Brunfaut tower and why it was chosen for this research	20

2.2.DESIGN FOR CHANGE ASSESMENT TOOLS	21
24 GUIDELINES TO TRANSFORMABLE DESIGN – QUALITATIVE	21
Neighbourhood level.....	21
Building level.....	22
MATERIAL PASSPORTS – QUALITATIVE	23
SCENARIO PLANNING –QUALITATIVE	24
LIFE CYCLE ASSESSMENT – QUANTITATIVE	25
Totem.....	26
Ecolizer.....	26
NIBE environmental classification system.....	26
Eindnoten.....	29
TIMELINE DEVELOPMENT METHOD	31
3.1.TIME LINE DEVELOPMENT METHOD	31
DESIGN PHASES	33
DESIGN ASPECTS	34
DESIGN PROCESS	34
Timeline arrows.....	34
Decision moments.....	35
3.2.CASE SPECIFIC TIMELINE DEVELOPMENT	37
PETERBOS #9 – 5 IN4E & LACATON&VASSAL	37
Information used to build the timelines.....	37
Conceptual design phase.....	37
Developed design phase.....	38
Detailed design phase.....	40
COSMOPOLITAN	42
conceptual design phase.....	42
Detailed design phase.....	43
Execution phase.....	44
	44

TOUR BRUNFAUT – A229 & DETHIER	46
Feasibility study.....	46
conceptual design phase	46
Developed design phase	48
Detailed design phase.....	48

3.3. RETROSPECTIVE REFLECTION AND FINDINGS 50

RETROACTIVE REFLECTION ON THE ANALYSIS METHOD 50

INSIGHTS RECEIVED FROM THE METHOD 50

Comparison of design phases over the three case studies.....	50
Speed of the design process	51
Influence of the budget	52
Different actors in the design process.....	52
How important was sustainability for the architects?.....	53
Conclusion	54

3.4. SELECTING KEY PHASES FOR EACH OF THE DESIGN ASPECTS 55

FUNCTION 60

STRUCTURAL DESIGN 61

MATERIALS 62

INHABITED CONSTRUCTION 63

TECHNIQUES 63

Eindnoten	64
-----------------	----

PROOF OF POTENTIAL 67

4.1. KEY-MOMENT I: FUNCTION - THE CONCEPTUAL DESIGN PHASE – SCENARIO PLANNING - COSMOPOLITAN 69

SCENARIO PLANNING ILLUSTRATED ON THE COSMOPOLITAN 69

why could a change in function take place?.....	69
---	----

Does the cosmopolitan answer the requirements to become a school?.....	69
--	----

RATE OF CHANGE	73
----------------------	----

REACTION OF THE PROJECT’S ARCHITECT 73

4.2. KEY-MOMENT 2: STRUCTURAL DESIGN & MATERIAL – DEVELOPED DESIGN PHASE – NIBE & ECOLIZER - PETERBOS #9	74
<u>ECOLIZER AND NIBE ENVIRONMENTAL CLASSIFICATION SYSTEM ILLUSTRATED ON PETERBOS #9</u>	<u>74</u>
Ecolizer	74
NIBE environmental classification	75
<u>REACTION OF THE ARCHITECTS</u>	<u>77</u>
4.3. KEY-MOMENT 3: MATERIAL - DETAILED DESIGN PHASE – 24 GUIDELINES TO TRANSFORMABLE DESIGN - TOUR BRUNFAUT	78
<u>24 GUIDELINES TO TRANSFORMABLE DESIGN ILLUSTRATED ON TOUR BRUNFAUT</u>	<u>78</u>
Reversibility – interfaces	78
Simplicity – interfaces	78
Speed – interfaces	79
Durability – components	79
Reuse of existing components – components	79
Compatibility – components	79
Layering – composition	80
Independence – composition	80
Prefabrication – composition	81
Conclusion	81
<u>REACTION OF ARCHITECTS</u>	<u>82</u>
Eindnoten	83
CONCLUSION	85
Further research	86
BIBLIOGRAPHY	87
bibliography of chapter 1	87
bibliography of chapter 2	88
bibliography of chapter 3	89
bibliography of chapter 4	90

ANNEX 1 : THE DESIGN PROCESS OF PETERBOS #9 - INTERVIEW 1	95
ANNEX 2: THE DESIGN PROCESS OF THE COSMOPOLITAN - INTERVIEW 1	103
ANNEX 3: THE DESIGN PROCESS OF TOUR BRUNFAUT-INTERVIEW 1	107
ANNEX 4: THE DESIGN PROCESS OF PETERBOS #9 & DISCUSSION DESIGN FOR CHANGE ASSESSMENT TOOLS - INTERVIEW 2	111
ANNEX 5: THE DESIGN PROCESS OF THE COSMOPOLITAN & DISCUSSION ON DESIGN FOR CHANGE ASSESSMENT TOOLS - INTERVIEW 2	117
ANNEX 6: THE DESIGN PROCESS OF TOUR BRUNFAUT & DISCUSSION ON DESIGN FOR CHANGE ASSESSMENT TOOLS - INTERVIEW 2	122

LIST OF IMAGES

- Image 1.1: principle of circular economy compared to linear economy.
- Image 1.2: post-war high-rise building before renovation
- Image 1.3: Post-war high-rise building after renovation
- Image 1.4: Practical, graphical illustration of a design process
- Image 1.5: the five-step design process initiation, preparation, proposal making, evaluation and action
- Image 1.6: Transparent layering system
- Image 1.7: Riba plan of work
- Image 1.8: diagram of a design process by Markus/Maver
- Image 1.9: Timeline developed by Meex
- Image 1.10: Layers identified by Brand
- Image 1.12: The four groups of generators stacked in order of flexibility
- Image 2.1: conceptual building system for the case study peterbos#9
- Image 2.2: renovation of grand parc, bordeaux. comparison between before (left) and after (right) renovation
- Image 2.3: close up on one wintergarden of the renovation in grandparc, Bordeaux
- Image 2.4: interior view on the wintergardens of the renovation in grand parc, bordeaux
- Image 2.5: conceptual render on the exterior of Peterbos#9
- Image 2.6: conceptual render of the interior of peterbos#9
- Image 2.7: photographs of the exterior of the Cosmopolitan
- Image 2.8: renovation concept for tour brunfaut by A229
- Image 2.9: illustration of buildings with decreased extencibility (left) and increased extecibility (right)
- Image 2.10: four possible scenarios for a single-family home
- Image 2.11: exemplary page showing the information on the environmental impact of the building product
- Image 3.1: RENDER OF THE COMPETITION PROJECT
- Image 3.2: The schemes show the main principles of the buffer effect of the wintergardens
- Image 3.3: conceptual render made for the competition of the cosmopolitan
- Image 3.4: interior sketch of the wintergarden serving as circulation space for duplex apartments
- Image 3.5: photoghaph of the built facade
- Image 3.6: the structural concept to bear the extra four level added to tour brunfaut
- Image 3.7: schemes made for the competition. a clear material concept is already developed
- Image 3.8: scheme for the planning of the inhabited construction in Tour Brunfaut
- Image 4.1: possible layout for an abrupt conversion of the top floors into a school
- Image 4.2: conceptual drawing of dependand structures (left) and independent structures (middle & right)

LIST OF TABLES

- Table 1: list of all interviews and their place in the annex
- Table 2.1: categorization of the guidelines to design for change by OVAM
- Table 2.2: input and output for the neighbourhood level of the 24 guidelines on transformable desing
- Table 2.3: INPUT AND OUTPUT FOR THE building LEVEL OF THE 24 GUIDELINES ON TRANSFORMABLE DESING
- Table 2.4: INPUT AND OUTPUT FOR THE element LEVEL OF THE 24 GUIDELINES ON TRANSFORMABLE DESIgn
- Table 2.5: INPUT AND OUTPUT of a material passport
- Table 2.6: INPUT AND OUTPUT of scenario planning
- Table 2.7: INPUT AND OUTPUT of Totem
- Table 2.8: input and output of nibe environmental classification system
- Table 2.9: INPUT AND OUTPUT of the nibe environmental classification system
- Table 2.10: environmental classes established by Nibe
- Table 3.1: understanding design phases inspired by both Elke meex and riba plan of work
- Table 3.2: scenarios, influences on the scenarios and why a certain scenario was preferred to another
- Table 4.1: overview of the key moments, tools and case studies that will be discussed in the following chapter.
- Table 4.2: requirements to be suitable as school building
- Table 4.3: PRELIMINARY results obtained from using the Ecolizer
- Table 4.4: Nibe classification method, applied to the structural scenarios of Peterbos#9
- Table 4.5: categories and guidelines on the element level
- Table 4.6: summary of the analysis with 24 guidelines to transformable design.

THESIS OUTLINE

CHAPTER 1: INTRODUCTION

This chapter explains the field in which this thesis is situated, the main goals of the thesis and the research method.

CHAPTER 2: CASE STUDIES AND DESIGN FOR CHANGE ASSESSMENT TOOLS

This chapter introduces the case studies and design tools that were studied in this master thesis. They form the base of the research. For each case study, the main concepts are introduced as well as the designing architectural offices. Furthermore, the goal, required information and outcome of each design for change assessment tool is listed in the second part of this chapter.

CHAPTER 3: TIMELINE DEVELOPMENT METHOD

The first part of this chapter, explains the concepts and parameters required to construct the timelines with the timeline development method that is established in this masterthesis. Therafter, the method is applied to analyse the design process of the three case studies. These analysis are used to retrospectively conclude certain trends, influencing factors and main actors in the design process. The last part of chapter utilizes this information to find moments in the design process where a tool could be the most effective.

CHAPTER 4: PROOF OF POTENTIAL

Chapter four illustrates the potential of design tools, with three examples where a tool is applied on a case study in the moment assigned in chapter three. The results were presented to the project architects of each of the case studies to spark a discussion between architecture and practice.

CHAPTER I

INTRODUCTION

I.1. SHIFTING APPROACHES TO THE BUILT ENVIRONMENT, FROM LINEAR TO CIRCULAR

As the awareness for the environment grows in Europe, the environmental impact of the building sector becomes more and more apparent. Buildings consume 40% of Europe's energy request and account for 36% of Europe's CO₂ emissions.¹ Energy regulations imposed by the European union were a first attempt to lowering the impact. However, these laws currently only focus on energy consumption during the usage phase of buildings. The energy consumption of buildings before and after their use is currently not taken into account when it comes to regulations.²

“Scientific research has shown that once the energy consumption of a building is minimized, a further reduction of the global energy use and the environmental impact can be achieved by managing the building materials and building components over the full life cycle of the building.”³

The impact of the throw-away mentality has been the economic model for decades and cannot be neglected when speaking about environmental impact, especially that of the building industry. In Belgium, an average of 15 million tons of building waste is produced each year.⁴ By eliminating the waste production of the building industry it's environmental impact would be enormously reduced. This becomes urgent, when looking at the decreasing European material reserves and our recourse dependency on neighboring continents.⁵

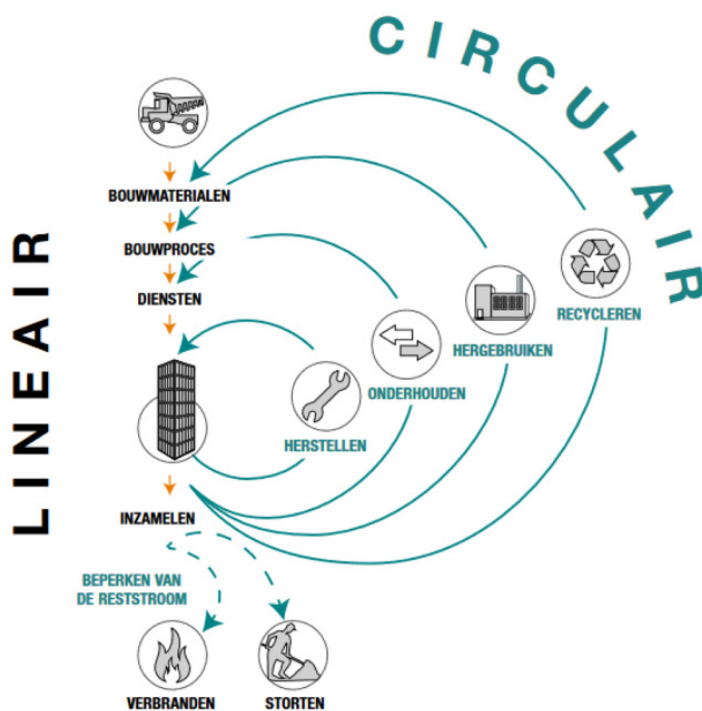

Image 1.1: principle of circular economy compared to linear economy.⁶

Over the past decade a large amount of research has been conducted to identify solutions for the large amount of waste production of the building industry. This research led to circular material models and implementation strategies like ‘Design for Change’. Image 1 shows the principle of circular economy, by designing out waste and closing loops, materials and components can be maintained, reused or recycled. In this circular economy, these components maintain their value and functionality, resulting in the decrease or even complete elimination of waste compared to a conventional linear waste chain.⁷

Applying strategies like Design for Change allows architects to foster such a circular economy by designing so called dynamic buildings; using reversible connection for example, allows building components to be reused during the subsequent renovations. More generally speaking, Design for Change is a strategy that takes into account the building requirements of the future. It brings forward concepts and techniques on how these unsure requirements can be fulfilled more easily through adaptability and generality with ecology, economy and social aspects in mind.⁸

Lately even more detailed and practical research has been carried out, resulting in tools and concrete design strategies that architects can adopt in their design to create a more circular building. Technical and theoretical knowledge is largely already there. The implementation of this knowledge in practice, however, is quite rare.^{9 10}



Image 1.2: post-war high-rise building before renovation¹¹



Image 1.3: Post-war high-rise building after renovation¹²

POST-WAR HIGH-RISE

During the 60's and 70's a large number of post-war high-rise buildings were constructed in Belgium. Many of them were social housing buildings with small, but clean apartments for the underprivileged, subsidized by the law *Brunfaut*.¹³ Today, many post-war high-rise buildings no longer meet the requirements of the contemporary living. They suffer from various problems, e.g. outdated technical installations, fire safety and circulation issues, poor acoustic insulation and insufficient thermal performance of the building shell.¹⁴

One solution to deal with this problem would be to demolish these high-rise buildings. However, doing so could have many negative consequences. As population in Belgian cities is growing, so is the request for housing¹⁵. Demolishing a high-rise tower would mean the loss of many dwellings. Moreover, the amount of waste that would be produced, especially since their load-bearing structure is generally still intact. The repetitiveness in these buildings makes them even more interesting for renovation. Renovating a post-war high-rise building will still generate a large amount of waste, due to asbestos removal, replacement of deteriorated materials, ... These materials are then replaced by new, energetically better performing materials that are often connected in a non-reversible way. Meaning that, when these materials become outdated, they will generate once again a lot of waste during the next renovation. By taking into account future renovations when renovating in the present, the reuse of certain components can be foreseen. For this reason, the case-studies in this thesis will focus on post-war high-rise renovations.

1.2. RESEARCH GOALS & AIMS

Today, there is a growing interest among architects to be supported and encouraged to use design tools and strategies that will improve the environmental impact of their design. This can be seen from initiatives as the *Green Deal Circulair Bouwen*, the many lectures and trainings on Circular Building and engagement of the researchers of VUB Architectural Engineering in for example the Open Call projects of *Circular Flanders*.^{16 17}

As mentioned above, the use of design tools and strategies fostering a building adaptability and component reuse, is a way to support architects in making choices that can improve the circularity of their designs. However, **to understand how these design tools can be implemented effectively in the most efficient way, one must first understand the impact of all actors, influencing factors and the dynamic development of a design process.** The objective is to shed light on why existing tools and strategies for circular buildings do not find their way into a design process, and understand how a better match could be made between tools and designers and which improvements are necessary.

To achieve that objective, this master thesis explores the evolution of post-war high-rise renovations through the analysis of their design processes. Following an adapted time-line method, it attempts to cast light on the reasons for certain decisions and what and who influences them in three different case studies. Being conscious of these factors can influence the way researchers and architects look at a design process. By identifying key phases in the design process, the research will give insight about where in the design process the introduction of a design tool or strategy could be implemented to improve the adaptability, circularity and thus environmental life cycle impact of the project.

Finally, testing whether a certain tool will actually make a difference in the final design is not in the scope of this thesis; that would require more case studies and longer design process observations unfeasible within the time scale of this thesis research. The goal is to explore and illustrate the possibilities of an improved match between designers and design tools and open the minds of the architects as well as of tool developers. The real testing and validation could only be done with multiple and extensive workshops and observations.

I.3. STATE OF AFFAIRS IN DESIGN RESEARCH: EXISTING ANALYSES OF DESIGN PROCESSES

Analyses of design processes have been done to serve different architectural research fields. This section will introduce several analyses that have been the foundation of the adapted analysis method developed, adopted and evaluated in this master thesis. Therefore, three perspectives can be taken: process theories, process analysis methods and actor involvement.

THEORIES ON DESIGN PROCESSES

To realize the timeline development method in the further chapters, a basic knowledge on existing design process theories has to be established. The following paragraphs explain different approaches from which theorists analyse design processes to understand the way designers think.

Literature about design processes shows many models, from circular to triangular. Image 4, developed by Lawson, illustrates for example how the design process can be understood as twisting between analysis, synthesis and evaluation. Analysis refers to the gathering of information. This information is then used to structure the problem. During the synthesis, the designer attempts to find an answer to this problem by creating solutions. Afterwards, the solutions are evaluated and reacted upon during the evaluation.

Image 5 shows another model, wherein the design process is circling initiation, preparation, proposal making, evaluation and action. The model, developed by Chokhachian in Image 6 also introduces that the design process is a transparent layering system, representing how earlier decisions work throughout different project stages. Through the final design, designers are able to look back at the decisions made in previous stages.¹⁸

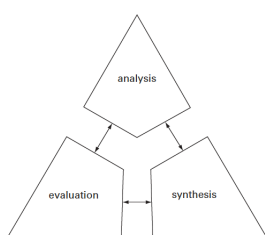

Image 1.4: Practical, graphical illustration of a design process¹⁹



Image 1.5: the five-step design process initiation, preparation, proposal making, evaluation and action²⁰

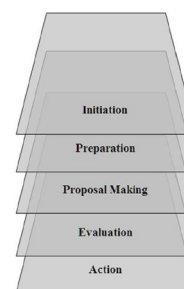

Image 1.6: Transparent layering system²¹

The previous models all focus more on a design process as continuous and planned decision making. While a design process can also be addressed as a series of ad-hoc choices made over time and influenced by different actors in a complex project setting. They are also theoretically developed and according to Chokhachian (2014) the writers of these models “[...] have not offered any evidence that designers or architects systematically follow their maps.”

A more commonly known design process timeline, apparently more closely related to practice, is the RIBA plan of work, seen in Image 7. The design process is shown in a linear way from start to finish and divides the design process into different phases from the strategic definition to the in-use phase. For each phase, RIBA explains what should be done, the documents that should be prepared. It also gives a hint of when to look into sustainability by assigning sustainability checkpoints. The RIBA plan of work is not an analysis of a design process, but rather a description of what architects should do and what clients should expect from a contractual point of view.²²

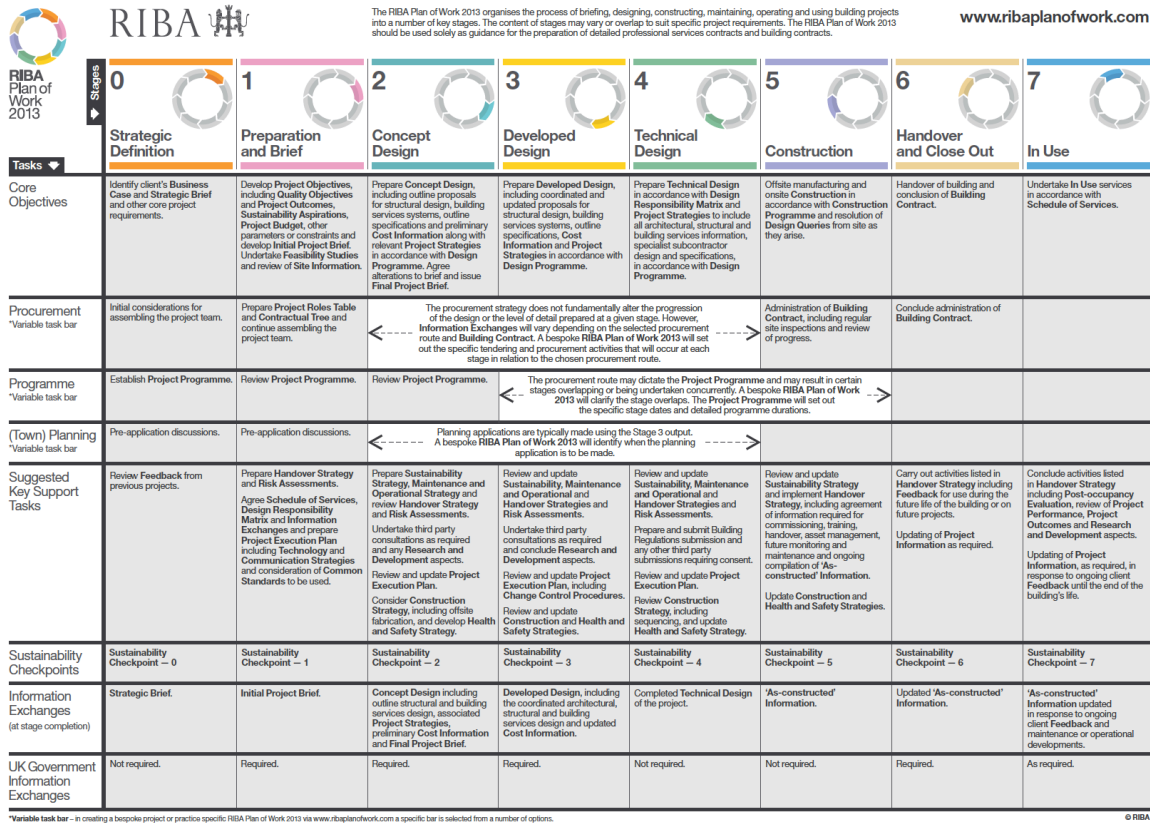

Image 1.7: Riba plan of work²³

This type of linear distribution of a design process over time has been critiqued, yet it does give a good overview of how the process works in the long term.²⁴ To introduce the decision-making models into the RIBA plan of work, Markus/Maver presented a model where the designer goes through decision sequences, close to the ones mentioned in Image 4, 5 and 6. Each line of their model can be linked to the design phases described by the RIBA plan of work. This way they portray the circular nature of designing and decision making, while still representing the linear nature of design timelines.²⁵

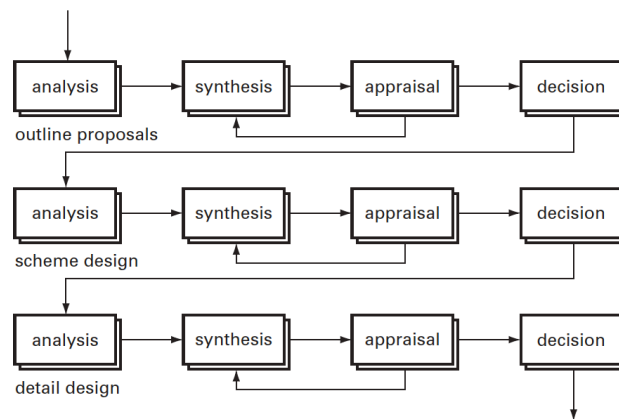

Image 1.8: diagram of a design process by Markus/Maver²⁶

“There is a danger with this [theoretical] approach, since writers on design methodology do not necessarily always make the best designers. It seems reasonable to suppose that our best designers are more likely to spend their time designing than writing about methodology. If this is true then it would be much more interesting to know how very good designers actually work than to know what a design methodologist thinks they should do!”²⁷

For this reason, this thesis adopts the idea of the design process as a linear model according to the RIBA plan of work and follows a bottom-up research, where the connection between theory and practice is key. However, in some cases, further in this thesis, patterns can be recognized, corresponding to the decision-making theories, explained in the beginning of this paragraph.

BOTTOM-UP DESIGN PROCESS ANALYSES TO UNDERSTAND HOW THE ENVIRONMENTAL IMPACT COULD BE IMPROVED

The interest in understanding a design process has been the topic in many research papers. An example are the researches that attempt to understand how a life cycle assessment (LCA) could lower the environmental impact when applied during the early design phases.^{28 29} Even though these researches focus mainly on the LCA assessment of the operational energy use or material consumption, their way of analyzing a design process, is done with the same goal as this thesis; find out when, who, and why decisions are made in order to support architects lower the long-term environmental impact of their choices.

In *Early Stage Design Decisions: The Way to Achieve Sustainable Buildings at Lower Costs*, Luís Bragança identifies the early stages of a design process as most influential on the environmental impact of the final design. In the beginning of the paper he describes different stages of the design process and identifies that the earlier stages in a design process have the least access on information about materials that will ultimately be used. He therefore attempts to create an LCA method that can cope with those uncertainties in early design stages.

The main source used as the base for this thesis is the doctoral thesis by Elke Meex, *Early Design Environmental Impact Assessment*. In her thesis, Meex establishes a methodology that allow architects to make better-informed decisions with regard to environmental impact. To understand the development of material choices during the design process, Meex establishes timelines, based on interviews in different architectural offices.

The results of the interviews are displayed on one linear timeline, shown in Image 7. To structure the timeline, the design process is divided into four design time-based stages (i.e. pre-design, design, permit and execution stage). The decisions that were made are further divided into categories, each related to one of the building layers identified by Brand^{30 31}. For each layer, Meex uses an arrow that changes width expressing how many offices took the same decision at the same time in the design process.

Her findings and methods were taken into account while conducting this research. The way of structuring into building layers in one dimension and time-based stages in the other is a clear, yet versatile way to structure a design process for the topic of this master thesis. However, the method had to be adapted in order to fit the case studies and goals of this research. For example, Elke Meex focusses on material choices, and on which building layer decisions are made. In his thesis, the design process is studied on a variety of aspects to find better correspondence with the design tools. Meex concentrates on newly build residential buildings, while this research will focus on renovation of post-war high-rise, wherein the design process (and stages) is dependent on the existing building. Therefore, the timelines in this thesis needed more flexibility in terms of design stages that don't necessarily correspond to the standard Flemish design process of newly build residencies.³²

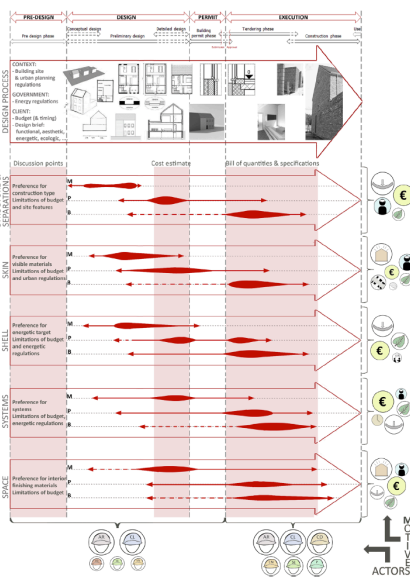

Image 1.9: Timeline developed by Meex³³

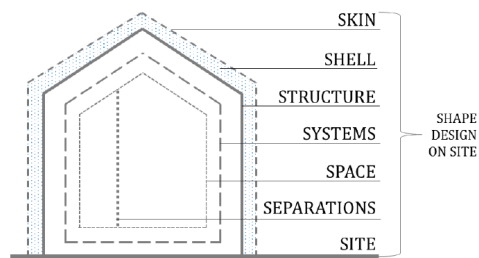

Image 1.10: Layers identified by Brand³⁴

MAIN ACTORS IN A DESIGN PROCESS

Finally, the identification of relevant actors below will complete this section. Since the architects are not the only ones taking decisions, it is important to identify the different actors and their role in the design process. The following paragraphs are based on the book, *how designers think. The design process demystified*, by Bryan Lawson. Many research is done on the interaction between client, designer user and legislator, but also on how designers make decisions or how designs are experienced differently by the actors.³⁵ These studies lean closer to social sciences and will not be in the scope of this thesis. However, attention will be paid to the influence of the actors on the design process. Therefore, basic knowledge on their role in the design process is required.

The clients are usually the actors who introduces the design challenge. they usually give the designer the task to answer it. Depending on the project and the type of client, the client could be a ‘creative partner’. As some clients are well experienced or even professionals. It is also a misconception to think that the client is just one person. In many cases a client could be an association or a group of people. Another misconception could be that the client is always the user. In many cases, for example large apartment buildings, a client has minimal contact with the users of the building.³⁶

The designer is expected to be creative, while still corresponding to all wishes of the client. The client-designer relationship is a rather complicated one. Depending on the type of client and project, the architect is freer. The designer wants to keep his reputation by leaving his mark on a building, while the clients know they want and are afraid the designer might have different ideas than theirs.³⁷

“The relationship between client and designer itself actually constitutes a significant part of the design process. The way that designers perceive and understand problems is to some extent a function of the way this relationship works.”³⁸

Perhaps one of the most influential actors in a design process is the legislator. He dictates many constraints in which the architects have to work. Legislators often appear as unreasonable and stubborn as they often hold on to rules that are not always useful or applicable in certain cases. On top of that, there are currently many legislators to which the designer has to answer.

“The architect today must satisfy the fire officer, the building inspector and the town planner and in addition, depending on the nature of the particular project, the housing corporation, health inspectors, Home Office inspectors, the water authority, electricity authority, the Post Office, factory inspectors, and so the list goes on.”³⁹

In Lawson stacks the actors from the rigid and inflexible legislators, on the bottom, to flexible designers on the top as illustrated in Image 9. The client is more flexible than the user, because he is in direct contact with the designer, who could convince him to be more agreeable.

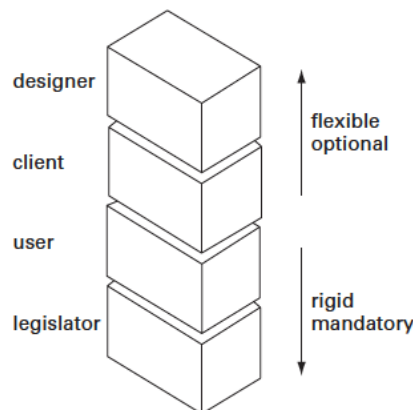
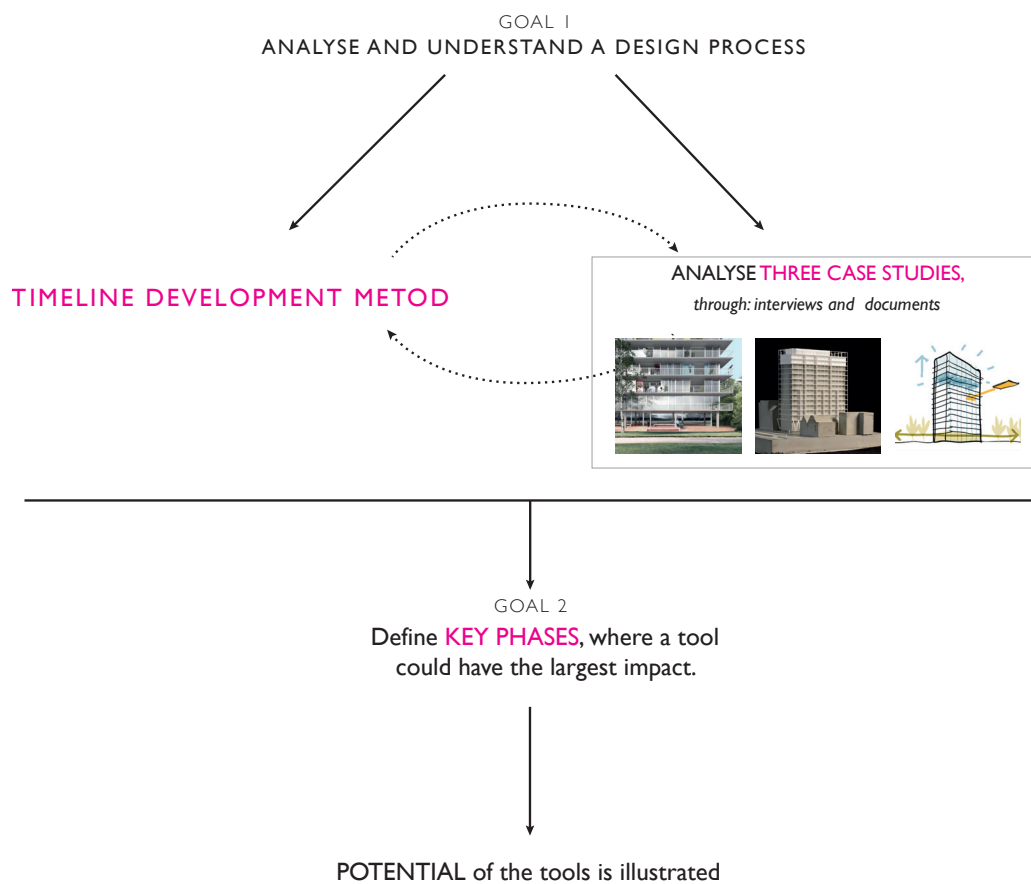

Image 1.12: The four groups of generators stacked in order of flexibility⁴⁰



1.4. RESEARCH METHOD

The first, and main phase of the research consists of understanding design processes. Through a bottom-up approach, a timeline development method is established while analyzing the design processes of three case studies. This method allows researchers to understand decisions and study the development of designs.

Information was gathered by interviewing three architectural offices twice about one specific project each. During the first interview, the architects explained the design process from their point of view, their struggles, their decisions, and their research. Certain strategic questions about tools and actors guided the interview. However, it was important to listen to their explanations before asking those questions. This would indicate what was most significant or influential in their specific design process. Towards the end of the research, preliminary timelines were further discussed with the architects in a second interview to review their accuracy and discuss certain elements into further detail. After the interviews, the preliminary timelines were finalized, using the information from the second interview. Detailed information on all six interviews can be found Table 1.1 the full interviews are written down the in the annex.

The information received from the final timelines was then, in a second phase, used to connect certain design phases, to design for change assessment tools and strategies. These design phases will be called key phases. They indicate a phase in the design process where a design tool could have the largest impact. The application of one design tool on a key phase in each of the case study timelines illustrates the potential of what design tools can accomplish. Presenting the results to the architects sparked an interesting discussion between practice and theory.

Table 1.1: list of all interviews and their place in the annex

	PETERBOS #9	COSMOPOLITAN	TOUR BRUNFAUT
THE INTERVIEWEES AND LEAD ARCHITECTS OF THE PROJECT.	Jan Opdekamp Ruben Janssens	Lourenço van Innis	Renaud Van Espen
DATE OF THE FIRST INTERVIEW	06/11/2018	19/11/2019	20/11/2019
LANGUAGE SPOKEN DURING THE INTERVIEWS	Dutch	English	French
MAIN SUBJECTS DISCUSSED IN THE FIRST INTERVIEW	The evolution of the project through the design process.	The evolution of the project through the design process.	The evolution of the project through the design process.
PLACE IN ANNEX	Annex 1	Annex 2	Annex 3
DATE OF THE SECOND INTERVIEW	09/05/2019	06/05/2019	02/05/2019
MAIN SUBJECTS DISCUSSED IN THE SECOND INTERVIEW	The developed timelines + tools applied to the key moment in the project	The developed timelines + tools applied to the key moment in the project	The developed timelines + tools applied to the key moment in the project
PLACE IN ANNEX	Annex 4	Annex 5	Annex 6

The next chapter will introduce the case studies analysed in this thesis, as they will be the main source of information on the characteristics of design processes. As explained above, the analysis of their design processes forms the base for the timeline development method established in chapter three. The next chapter will also explain the different reversible design tools and strategies that were taken into account for this thesis.

EINDNOTEN

- 1 Ambroise Romnée and Jeroen Vrijders, *Naar een circulaire economie in de bouw. Inleiding tot de principes van de circulaire economie in de bouwsector* (Brussels: WTTCB, 2018).
- 2 Vlaams energieagentschap, 'Nieuwe EPB-Eisen Voor 2019 Voor Nieuwbouw En Renovatie' (Vlaamse overheid, November 2018).
- 3 "Wetenschappelijk onderzoek toont echter aan dat eens het energieverbruik tijdens de gebruiksfase van gebouwen geminimaliseerd is, een verdere reductie van het globale energieverbruik en de milieu-impact voornamelijk ligt bij het beheer van de bouwmaterialen en bouwcomponenten over de volledige levenscyclus van gebouwen." Wim Debacker et al., 'Design for Change: Development of an Assessment and Transitional Framework (Summary)' (Mechelen: OVAM, 2015), <http://www.ovam.be/sites/default/files/atoms/files/TWOL-Design-for-change.pdf>.
- 4 Romnée and Vrijders, *Naar een circulaire economie in de bouw. Inleiding tot de principes van de circulaire economie in de bouwsector*.
- 5 Elke Meex, 'Circulair Bouwen in Vlaanderen?' (infosession, 7 May 2019).
- 6 Romnée and Vrijders, *Naar een circulaire economie in de bouw. Inleiding tot de principes van de circulaire economie in de bouwsector*.
- 7 Elke Meex.
- 8 Waldo Galle and Pieter Herthogs, 'Veranderingsgericht bouwen: ontwikkeling van een evaluatie- en transitiekader: Een gemeenschappelijke taal' (OVAM, 2015).
- 9 OVAM, '24 Ontwerprichtlijnen Veranderingsgericht Bouwen'.
- 10 Romnée and Vrijders, *Naar een circulaire economie in de bouw. Inleiding tot de principes van de circulaire economie in de bouwsector*.
- 11 P&P architectes, 'Peterbos', p&p Architectes SPRL, accessed 1 June 2019, <http://www.pparchitectes.com/peterbos.html>.
- 12 P&P architectes, 'Peterbos', p&p Architectes SPRL, accessed 1 June 2019, <http://www.pparchitectes.com/peterbos.html>.
- 13 (Hoet 2013)
- 14 Anne Paduart, 'Re-Design for Change: A 4 Dimensional Renovation Approach towards a Dynamic and Sustainable Building Stock' (Doctoral thesis, Vrije Universiteit Brussel, 2012).
- 15 'België Telde Op 1 Januari 2018 | 1.376.070 Inwoners | Statbel', accessed 14 April 2019, <https://statbel.fgov.be/nl/nieuws/belgie-telde-op-1-januari-2018-11376070-inwoners>.
- 16 <https://vlaanderen-circulair.be>, 'Green Deal Circulair Bouwen', Vlaanderen Circulair, accessed 1 June 2019, <https://vlaanderen-circulair.be/nl/onze-projecten/detail/green-deal-circulair-bouwen>.
- 17 <https://vlaanderen-circulair.be>, 'Open Call - Vlaanderen Circulair', accessed 1 June 2019, <https://vlaanderen-circulair.be/nl/aan-de-slag/open-call>.
- 18 Ata Chokhachian, 'Studies on Architecture Design Procedure A Framework for Parametric Design Thinking', n.d., 147.
- 19 Bryan Lawson, *How Designers Think: The Design Process Demystified*, 4. ed (Amsterdam: Elsevier/ Architectural Press, 2006).
- 20 Chokhachian, 'Studies on Architecture Design Procedure A Framework for Parametric Design Thinking'.
- 21 Chokhachian.
- 22 Lawson, *How Designers Think*.
- 23 RIBA, 'RIBA Plan of Work' (RIBA, 2013).
- 24 Lawson, *How Designers Think*.
- 25 Lawson.
- 26 Lawson.
- 27 Lawson.
- 28 Luís Bragança, Susana M. Vieira, and Joana B. Andrade, 'Early Stage Design Decisions: The Way to Achieve Sustainable Buildings at Lower Costs', *The Scientific World Journal* 2014 (2014): 1–8, <https://doi.org/10.1155/2014/365364>.
- 29 Elke Meex, 'Early Design Support for Material Related Environmental Impact Assessment of Dwellings' (Doctoral Thesis, UHasselt, 2018), <https://uhdspace.uhasselt.be/dspace/handle/1942/27512>.
- 30 Meex.
- 31 Steward Brand, *How Buildings Learn: What Happens after They're Built* (Viking Press, 1994).
- 32 Elke Meex, 'Early Design Support for Material Related Environmental Impact Assessment of Dwellings' (Doctoral Thesis, UHasselt, 2018), <https://uhdspace.uhasselt.be/dspace/handle/1942/27512>.
- 33 Elke Meex.
- 34 Steward Brand, *How Buildings Learn: What Happens after They're Built* (Viking Press, 1994).
- 35 Nathan Crilly, Anja Maier, and P John Clarkson, 'Representing Artefacts as Media: Modelling the Relationship Between Designer Intent and Consumer Experience', *International Journal of Design*, 2008, 14.
- 36 Lawson, *How Designers Think*.
- 37 Lawson.
- 38 Lawson.,86
- 39 Lawson.,89
- 40 Lawson.

CHAPTER 2

CASE STUDIES AND DESIGN FOR CHANGE ASSESSMENT TOOLS

This chapter will introduce the case studies and the design for change assessment tools as they form the base for the research carried out in chapter three and four. Familiarising with the case studies and explaining their origins is necessary to fit the developed timelines within a larger context and understand the relationship between the architects and their design. The second part of this chapter explains the design for change assessment tools or reversible design tools. Insight in the capacities of these tool is important to understand the further development of the thesis where the tools will be linked to key phases in the design process.

Image 2.1: conceptual building system for the case study peterbos#9 ¹

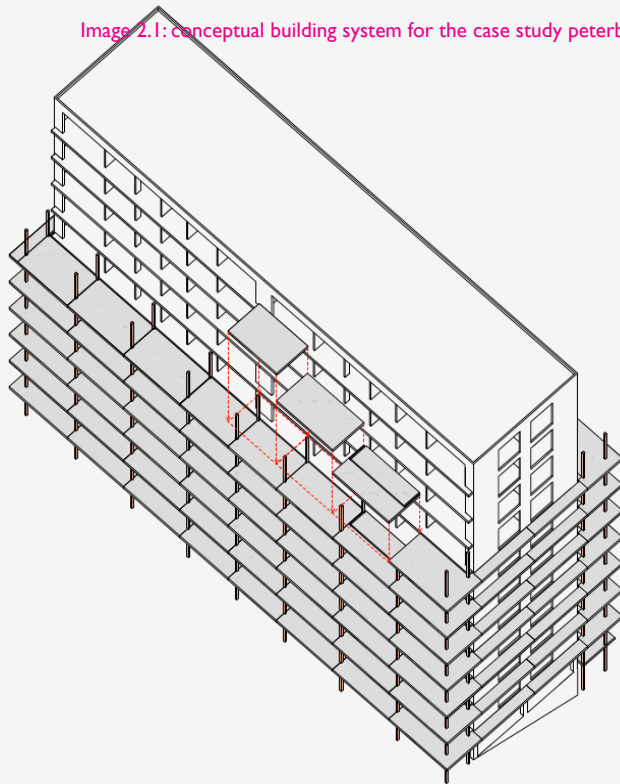

2.1. INTRODUCTION OF THE CASE STUDIES

Three case studies were used to develop and test the *timeline development method*. As mentioned before, this thesis will focus on the renovation of post war high-rise buildings, showing a different branch of architectural design than the new built case studies used by Elke Meex.² Renovation of post-war high-rise buildings was also chosen for its relevance in Belgium's contemporary building sector. To narrow the scope of the case studies even more, one specific type of renovation strategy was chosen. This makes comparing between the projects more convenient. The projects, used in this analysis, are applying a second façade to the building. This façade can serve as terrace, winter garden, but also as interior space. This horizontal extension allows to improve not only the energy performance, but also enlarge the apartment size and create extra outdoor spaces.³

This method got the attention through the work of the architectural office, Lacaton & Vassal. One of the main examples for this method are the renovations done by architecture office Lacaton & Vassal in particular the renovation in Grand parc, Bordeaux, a project that won the Mies van der Rohe award in 2019⁴. From their point of view *“one must never demolish, take away or replace, but protect, add, transform and use”*⁵ With this idea in mind, they developed a system where a second façade would be attached to the existing one. This façade would serve as a winter garden, increasing living space and enhancing energy performance. All of this while allowing the inhabitants to stay in their apartments during the renovations.⁶



Image 2.2: renovation of grand parc, bordeaux. comparison between before (left) and after (right) renovation⁷



Image 2.3: close up on one wintergarden of the renovation in grandparc, Bordeaux⁸



Image 2.4: interior view on the wintergardens of the renovation in grand parc, bordeaux⁹

Since each country has its own challenges and specificities when it comes to its construction sector. Therefore, the three case studies in this thesis are all located in Brussels to answer to a demand closer to home. These projects are all in a way inspired by the principle of Lacaton & Vassal. Yet, each project has given its own twist to the design, due to external and internal influences.

PETERBOS #9 – 51N4E + LACATON & VASSAL

Peterbos #9 is one of the many post-war high-rise towers built in the Peterbos park in Anderlecht, Brussels. The Brussel based office 51N4E won the competition for its renovation in collaboration with Lacaton & Vassal. This project strongly resembles the project in Bordeaux, mentioned above. However, due to Belgian regulations and influences specific to the Peterbos #9 building, the principles had to be adapted, to match these specific circumstances.^{10 11} At the time of the first interview, the architects had just submitted the building permit.



Image 2.5: conceptual render on the exterior of Peterbos#9¹²



Image 2.6: conceptual render of the interior of peterbos#9¹³

51N4E

51N4E was founded in 1998. Currently the office counts 22 members and is led by Johan Anrys and Freek Persyn. 51N4E focusses mostly on large scale projects, that range from housing to public buildings to even urban design. They strive for innovation by participating in research projects as for instance, strategies like Brussels 2040.

LACATON & VASSAL

The Paris based architecture office, Lacaton & Vassal was founded in 1987 by Anne Lacaton and Jean-Philippe Vassal. The quote above already explained their main philosophy; to renovate before demolishing. Like 51N4E, Lacaton & Vassal are involved in many types of projects, urban strategies, housing projects, cultural buildings, ... They are active in renovations as well as new buildings.

PETERBOS #9 AND WHY IT WAS CHOSEN FOR THIS RESEARCH

In the proposal of 51N4E for the renovation of the Peterbos #9 building, the goal is to find the 'optimal minimum' *"not to renew everything, but make a qualitative renovation"*¹⁴. They focus on creating a significant added value for a reasonable price, cheaper than demolishing the existing building and rebuilding a new one. 51N4E proposes a method that is not unique for this building, but can be applied to other post-war high-rise buildings in similar circumstances. This way they want to encourage owners of similar projects to renovate instead of demolish, while enhancing the living qualities.¹⁵

The largest intervention in the building is the remodeling of the west and east façades. 51N4E and Lacaton & Vassal propose to add an extra four meters of terraces to the outside of the building using a separate structure. These terraces can be closed off with glass windows during wintertime to create a winter garden, that becomes part of the living space. In summertime, they can be opened to become big terraces.¹⁶

One of the goals to make this building more sustainable was to build the façade system

circular and sustainable. A quite large amount of time went to designing façade systems in different materials with different structures. However, due to circumstances, they were not able to choose the most circular solution. For this master thesis, it is interesting to observe why. Another interesting aspect to study is the influence of the presence of the inhabitants during the renovation, the inhabited construction, on their design process.

17

COSMOPOLITAN – BOGDAN & VAN BROECK

The cosmopolitan project concerns the reconversion and renovation of an office building and hospital into a residential tower. This project is different from the other two case studies as it is not a social housing project. In 2014, the architectural office, Bogdan & Van Broeck, won the competition for this renovation. At the time of the first interview, the construction of the building was almost completed.



Image 2.7: photographs of the exterior of the Cosmopolitan¹⁸

BOGDAN & VAN BROECK

Bogdan & Van Broeck is a Brussel-based architecture office, founded by Oana Bogdan and Leo Van Broeck in 2007. Both founding partners are active in political debates about urban design, architecture and building strategies. Van Broeck as the *Flemish government architect (Vlaamse bouwmeester)* and Oana Bogdan as *Secretary of State at the Ministry of Culture* in 2016-2017 in Romania she also promotes the power of cultural heritage to create social cohesion together with the *civic platform Romania 100*.¹⁹ The office focusses, as the previous architecture offices, mainly on large scale projects (e.g. residential buildings, schools, parks, public space)

THE COSMOPOLITAN AND WHY IT WAS CHOSEN FOR THIS RESEARCH

Although the renovation strategy for the cosmopolitan shows similarities with Peterbos #9, applying it to the cosmopolitan resulted in a different outcome. The building is extended in the vertical and horizontal direction. Vertically, three extra levels are added on top of the existing building. The horizontal extensions are completely carried out in steel and serve as terraces, offering an outside space to each apartment.

As mentioned above, the building is not owned by a social housing company, but by a promotor of high-class apartments. This means that the client of the cosmopolitan will not be the future owner, since he will sell all apartments to individuals. Comparing the influences of the promotor in the design process to the owners of the other case studies could be an interesting track. Another difference with the other two case studies is that the cosmopolitan was transformed from an office building and hospital into a residential building.

TOUR BRUNFAUT – A229 + DETHIER ARCHITECTS

The third case study is also a social housing building. Tour Brunfaut, located along the canal in Molenbeek, was threatened to be demolished until the feasibility study by the previously mentioned Lacaton & Vassal, proved the “[...] extremely innovative and ambitious nature of the tower, not only from a technical but also a social perspective.”²⁰ The study served as the base for a competition to renovate the building, won by A229 and Dethier architects in 2014. At the time of the first interview, the architects were waiting for their building to be accepted.

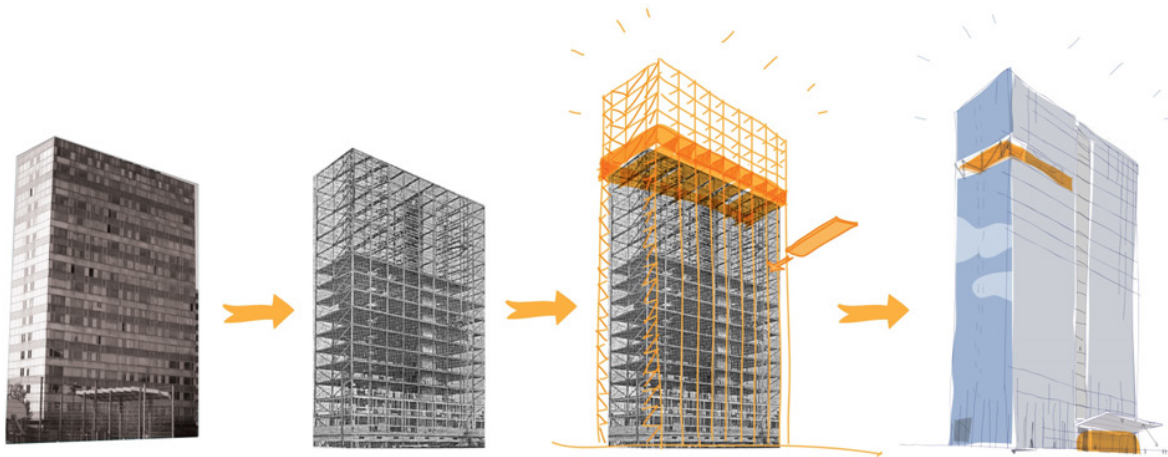

Image 2.8: renovation concept for tour brunfaut by A229²¹

A229

The Brussels based architectural office, A229, was founded in 1996 by Grégoire Houyet and Renaud Van Espen. Currently the office counts twelve collaborators. Their projects are located mainly in the field of residential and educational buildings. They focus on rationality and sustainability in their designs.²²

DETHIER ARCHITECTS

Dethier architects is based in Liege. Daniel Dethier established the office in 1992. Since then the office has worked on smaller scale projects (e.g. houses, a dentist practice) but also on larger projects (e.g. amphitheatres, office buildings). Today, Dethier architects counts four collaborators.²³

BRUNFAUT TOWER AND WHY IT WAS CHOSEN FOR THIS RESEARCH

In 2010, Lacaton & Vassal published a feasibility study in favor of renovating the tower. Here they suggested the same renovation strategy as Peterbos #9, add a horizontal extension and

keep the construction site inhabited.²⁴ A229 and Dethier architects won the competition for the renovation in 2014. The design for the renovation won a Be.Exemplary price, because of its attention for social and environmental sustainability.

Contrary to both Peterbos #9 and the Cosmopolitan, Tour Brunfaut uses the horizontal extension partially as interior space. By the use of façade panels, the new exterior walls are attached to the steel frame extension. Timber is used as flooring. A229 and Dethier architects show that they also paid attention to certain reversibility strategies, like making only reversible connections. Some suggestions from Lacaton & Vassal are, however, eliminated. For example, A229 will not work with an inhabited construction.²⁵







2.2. DESIGN FOR CHANGE ASSESMENT TOOLS

The following design tools will be considered to be applied to certain phases in the design process. They are ‘in-house’ tools, known to the researchers at the VUB Architectural engineering department. They inform architects on making better design choices with regard to reversible design and decrease the environmental impact. There are two categories of design tools: qualitative and quantitative. It is important to consider that these design tools are also chosen based on their usability as they should be implemented by architects during the design process. As the design tools are an important element in this master thesis, their characteristics and capacities will be explained. In the next chapters, the tools will be linked to specific moments in the design process, based on their input and outcome. A table at the end of each explanation indicates these two characteristics.

24 GUIDELINES TO TRANSFORMABLE DESIGN – QUALITATIVE

The “twenty-four guidelines to transformable building”, published by OVAM in 2016, are design principles that support architects to make better decisions with regard to dynamic building design.²⁶ The main focus of these guidelines is to minimise waste by extending the lifespan of buildings and their materials. The guidelines to transformable design focus on three scale levels i.e. neighbourhood level, building level and element level.²⁷ Therefore, their place in the design process is different.

Table 2.1: categorization of the guidelines to design for change by OVAM²⁸

	 Interfaces	 Sub-components	 Composition
 Element	Reversibility Simplicity Speed	Durability Reused Compatibility	Pace-layered Independence Prefabrication
 Building	Accessibility	Demountability Reusability Extensibility	Versatility
 Neighbourhood	Clear Adaptable	Retrofitted Dimensioned Removable	Unified Multipurpose Diverse Densifiable

NEIGHBOURHOOD LEVEL

The neighbourhood level focusses on an urban scale, e.g. connections of the building with its surroundings, how the neighbourhood is structured. It tries to question the flexibility of the neighbourhood (*simplicity* and *evolution*) and the use of durable solutions. For example, creating *diversity* within the neighbourhood, so it can more easily react to future changes. Another important goal is to allow as more greenspace into the surroundings by minimizing paved coverings of the ground (*dimensioning*) and creating multifunctional or reusable spaces (i.e. *multipurpose spaces* and *reuse*)²⁹

Table 2.2: input and output for the neighbourhood level of the 24 guidelines on transformable desing

INPUT	This level could/should be considered when designing the exterior spaces around the building and connection with the neighbourhood. (e.g. <i>simplicity</i> , <i>evolution</i> , <i>dimensioning</i> , <i>disassembly</i>) The neighbourhood level requires information about the surroundings and the building itself.
OUTPUT	Making design choices while following the guidelines will allow the architect (or urbanist) to design a flexible neighbourhood. It will help to define a more sustainable building concept, that could improve the adaptability to future changes. Some guidelines, however, could also help to define main concepts in a design. (e.g. <i>reuse</i> , <i>polyvalent space</i> , <i>diversity</i> , <i>infill functional change</i>)

BUILDING LEVEL

The building level concentrates on the diversity of the building. Connections between elements (e.g. wall-floor) are advised to be *accessible* in order to be able to *reuse* those elements. The guidelines recommend making a clear division between the main structure and the infill elements, since they both have a different life span. (*disassembly*) To react to possible functional changes it is recommended to ensure *extensibility* for interior modifications (e.g. technical) as well as vertical and horizontal expansions.³⁰

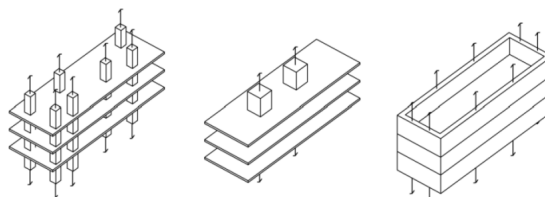

Image 2.9: illustration of buildings with decreased extencibility (left) and increased extecibility (right)³¹

Table 2.3: Input and output for the building level of the 24 guidelines to transformable design

INPUT	The building level requires information about the main goals of the client. Basic information of the existing building (in case of a renovation)
OUTPUT	Making design choices while following the guidelines will allow the architect (or urbanist) to design a building that can react to future changes in function, interior, exterior... It could also help to answer questions as <i>what will the façade look like?</i> <i>What type of bearing structure will be used and how will it interact with the interior spaces?</i> However, the detailed method of how the changes will be made, will not be the outcome of the guidelines on building level.

THE ELEMENT LEVEL

The element level focusses on detailed design e.g. how are the facades built? Can you reuse components after they have done their duty in one building? *simplicity, speed and reversibility* are the guidelines when it comes to interfaces between components. Elements, joined with simple connections that are quickly reversed, are more likely to be reused and replaced. In order to ensure that materials can be *reused* after their function has been fulfilled, the materials should still be in good shape. Therefore, one should pay attention to the use *durable* materials. Working with elements that are *compatible* with others, creates more options for the use of the element. The reuse of already existing materials should be encouraged. When combining the different materials into one element, attention should go to *independence* and *place-layering* according to lifecycle. This will improve the ease with which the materials can be replaced or removed without demolishing or damaging the neighbouring materials.³²

Table 2.4: Input and output for the element level of the 24 guidelines of transformable design

INPUT	This level could/should be consulted once the main design is drawn and the detailing should be elaborated.
OUTPUT	Making design choices while following the guidelines will allow the architect (or urbanist) to design building elements that can be changed and reused over time. It will also ease the replacement and removal of components in the elements without damaging any materials.

MATERIAL PASSPORTS – QUALITATIVE

Promoting a circular economy in the construction sector requires a large amount of information. Some of the information is already available, but not in a centralised place. Other information is unknown, or is not publicly available. Material passports were invented to centralise all available information in a logical and structured way. They are coupled to a material, element or component of the building and make it possible to update the information during the life cycles. Material passports provide the information to improve the circularity of a building and the possibility to reuse its components by providing detailed information about the building and its components. This will facilitate the future renovations as architects and contractors will be aware of which materials they will, and will not, be able to reuse. However, the material passports are only one step towards a circular building as the following quote explains.^{33 34}

“Having a passport does not necessarily make the product good for the Circular Economy. It is about what is in the passport. If the product indeed has good circular potential the passport is an enabler to fulfil that potential.”³⁵

Table 2.5: Input and output of a material passport

INPUT	In order to set up a material passport, one must have all the data on all the materials used in a building.
OUTPUT	The material passports will create a list that can help with the reuse of components during future renovations.

SCENARIO PLANNING –QUALITATIVE

In the fast-changing society of today, the future of a building is a large uncertainty. Economics, lifestyles, politics, ... are changing all the time. Reconversion of a building's function into a different one, usually goes hand in hand with an alteration of the building. A building that does not allow alteration will often be demolished, creating a lot of waste. To help architects imagine possible future changes and how a building should respond to those, the method of scenario planning was developed. When using this method, the architects envision different plots. Applying these plots to their designs will allow them to deduce which parts of the building should be adaptable.

Another important parameter in the scenario planning method is the speed with which the changes will happen. 'Does a building have to be adapted every 5 years or every 50?' 'Will the change happen gradually or will the building change its function all at once?'

One example is the change in a single-family home. Four possible scenarios for such a house are represented in Image 2.10: four possible scenarios for a single-family home. Scenario 2 and 3 show more divergent household types that have been emerging with the change in moral values and family compositions.³⁶ Image 2.10: four possible scenarios for a single-family home also illustrates the rate of change (e.g. scenario 1 and 2 have a higher changing rate than 3 and 4.) Other possible scenarios could be the change of a function (e.g. an office building turning into housing).

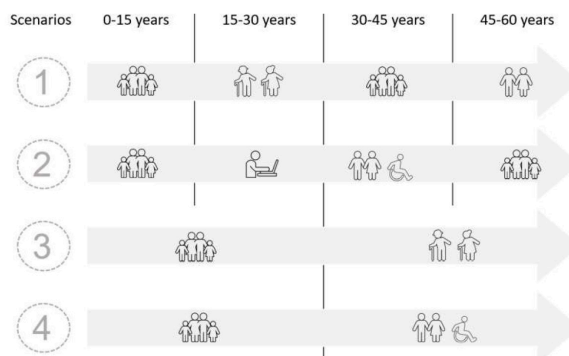

Image 2.10: four possible scenarios for a single-family home³⁷

Table 2.6: Input and output of scenario planning

INPUT	Scenario planning should be introduced when the main concepts are determined, but the design (i.e. wall placement, façade design) has not yet started.
OUTPUT	<p>Scenario planning can help to define project strategies</p> <p>In itself it does not ensure an adaptable building nor does it mean that less waste will be produced during a possible reconversion. However, it does open the mind of the architects and allows them to imagine which building elements should be adaptable (e.g. interior walls) or which elements should be over dimensioned (e.g. technical shafts). Scenario planning can also improve communication with the client, as it gives a clear image of why a certain investment is would be worth making.³⁸</p>

LIFE CYCLE ASSESSMENT – QUANTITATIVE

A life cycle assessment (LCA) is a commonly-used method to evaluate the potential environmental impact of a product or service throughout its full lifecycle, i.e. from the extraction, uses and reuses to finally the end of life of each material the product or service contains³⁹. An LCA is carried on in four stages: goal and scope definition, life cycle inventory, life cycle impact assessment and interpretation of the results.⁴⁰

In the second stage, life cycle inventory (LCI) an inventory of all materials and processes involved in the life cycle of the product is carried on, including the resources consumed and emissions released. In the third stage, life cycle impact assessment (LCIA), the information in this LCI is linked to the potential environmental problems the emissions could cause, for instance, land-use, greenhouse gasses⁴¹. An example of LCIA method is ReCiPe. This method calculates the environmental impact in two phases. In the first phase, one must calculate the impact with low uncertainty. Eighteen detailed categories, for instance, climate change, freshwater use, and marine toxicity are defined in this first phase. The second phase categorizes the impacts into three endpoint categories. Damage to human health, damage to ecosystem diversity and damage to resource availability, respectively each category counts for 40%, 40%, and 20% of the (aggregated) single score.⁴²

Applying the LCA method to buildings is a complicated task, due to the long and uncertain lifespan of a building, the combination of many materials of different sources and production processes, the evolution of these materials over time and the fact that each building is different.⁴³ Due to this complexity, the Flemish Public Waste Agency (OVAM - Openbare Vlaamse Afvalstoffen Maatschappij) created several tools allowing designers and architects to calculate their environmental impact in an easier way. Two examples of these tools are *Totem* and the *ecolizer*. Both tools are largely based on the same LCI database,ecoinvent, but they both use a different LCIA method. Where the *ecolizer* is based on the ReCiPe method, explained above, *Totem* utilizes a monetarization method.⁴⁴ This is a method that converts CO₂ emissions into € to show the costs needed to repair the environmental damage or to prevent the environmental damage the exploitation, use and end of life treatment could cause.⁴⁵ However, to simplify the calculations, many assumptions are made behind the numbers in these tools, making them less certain than a full lifecycle analysis. Another disadvantage is the fact that the *ecolizer* and *Totem* take only the first life of materials into account.⁴⁶ Therefore, the information obtained from these tools is rather indicative and indicates the potential damage made to the environment even less accurate than a full LCA would provide.

TOTEM

Totem is an inter-regional, online tool, developed to calculate the environmental impact of buildings and building elements. It is directed towards architects and engineering offices.⁴⁷ The user must indicate the composition of the building, including the type and quantity of materials. Users can choose building elements from the Totem library or create their own by combining different materials into one element. The library, included in Totem, contains many standard Belgian building materials.

Depending on the amount of information given to the program, Totem can calculate the environmental impact on building level as well as element level. Currently, the tool does not take reversibility and transformability into account. However, it will probably consider them in future versions.⁴⁸

Table 2.7: Input and output of Totem

INPUT	Totem requires the user to be able to indicate specific building element setups. The amount of each material in the building has to be known to obtain relevant results.
OUTPUT	The user will receive an environmental impact score. Comparing different scores can help the user to on which specific material to choose.

ECOLIZER

The *ecolizer* tool focusses on a broader field of designers (e.g. product designers, interior designers). The material used in the project and their processing method are listed. Each material and processing method corresponds to a number of environmental points given by the *ecolizer*. These points indicate the environmental impact for each material and processing method. Adding up all the environmental points will allow the user to calculate the effect of the project on the environment.⁴⁹

However, given the small amount of time designers have to make decisions and do research on the materials they are using, The *ecolizer* appears to be appropriate for small and fast calculations on the impact of materials on the environment.

Table 2.8: input and output of nibe environmental classification system

INPUT	The <i>Ecolizer</i> requires the user to know or estimate the amounts of each material in a project and how these materials are processed before their use.
OUTPUT	The user will receive an environmental impact score. Calculating scores for different materials and how they are processed, allows the designer to compare and make better informed choices. This can help when choosing the main materials used in a design.

NIBE ENVIRONMENTAL CLASSIFICATION SYSTEM

Another interesting tool to simplify a LCA is the NIBE environmental classification, developed by The *Dutch Institute for Building biology and Ecology* (Nederlands Instituut voor Bouwbiologie en Ecologie, NIBE). The system classifies building products according to their environmental impact. The different classes are listed in Table 2.10. For each product, the specific impacts (e.g. greenhouse gasses, human toxicity) are specified in a series of graphs. This way the user can evaluate for himself which parameters he wants

to focus on when making design choices. The NIBE environmental classification system quickly informs architects and other actors in the design process of the environmental impact connected to choices of materials certain design.⁵⁰

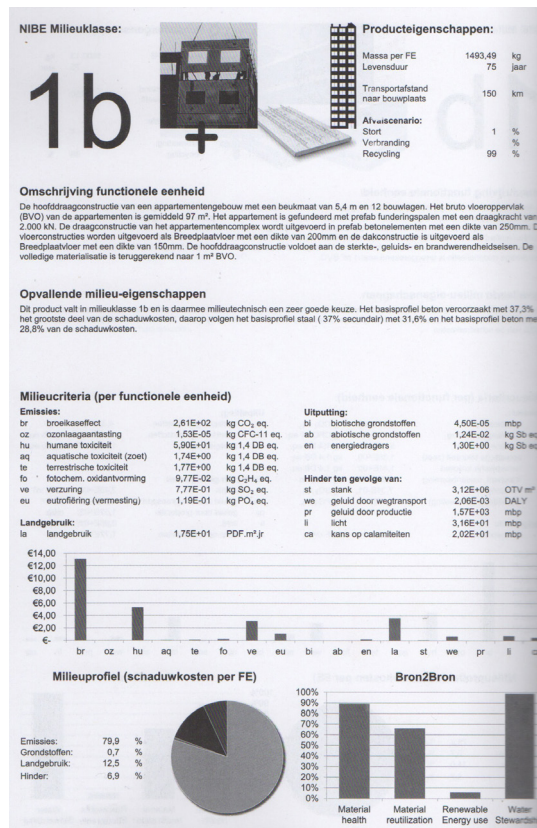

Image 2.11: exemplary page showing the information on the environmental impact of the building product for specific environmental criteria

Table 2.9: INPUT AND OUTPUT of the nibe environmental classification system

INPUT	To use NIBE classification system information should be given about the materials the designer wants to use in the project. For certain products, the tool requires information about the function of project and minor structural choices.
OUTPUT	The user will be able to trace the environmental class of the product. He will also be aware of the specific environmental impact of this product. This will allow him to compare different materials and make better informed choices.

Table 2.10: environmental classes established by Nibe⁵¹

CLASS	SUBCLASS	DESCRIPTION
1	a b c	Best choice
2	a b c	Good choice
3	a b c	Acceptable choice
4	a b c	Not an optimal choice
5	a b c	Not recommendable
6	a b c	Bad choice
7	a b c	Unacceptable choice
>7c		

The three case studies give versatile, yet similar angles on the design processes of post-war high-rise renovations. The fact that all three case studies apply the same renovation method, makes them easily comparable. However, they differ in the way this method was applied, but also in the type of client who owns the building and the previous experiences of the architectural offices. The variety of tools, explained in this chapter, addresses different elements of a design. Resulting in a diversity of in- and outputs for each tool. The knowledge and information explained in this chapter will serve as a base for the timeline development method that will be established in the next chapter.

EINDNOTEN

- 1 5IN4E and Lacaton & Vassal, 'Peterbos #9 Brochure', 12 October 2017.
- 2 Elke Meex, 'Early Design Support for Material Related Environmental Impact Assessment of Dwellings' (Doctoral Thesis, UHasselt, 2018), <https://uhdspace.uhasselt.be/dspace/handle/1942/27512>.
- 3 David Huber, 'Lacaton & Vassal. Game Changers', Metropolis, January 2016.
- 4 Niall Patrick Walsh, 'Grand Parc Bordeaux Wins 2019 EU Prize for Contemporary Architecture - Mies van Der Rohe Award', ArchDaily, 11 May 2019, <https://www.archdaily.com/914806/grand-parc-bordeaux-wins-2019-eu-prize-for-contemporary-architecture-mies-van-der-rohe-award>.
- 5 Vincent Degrune, 'The Brunfaut Tower. Presentation of the Conceptual Design Challenges of a Renovation.' (The energy future of existing buildings in Brussels: between preservation and performance, Brussels: Brussels urban development, 2014), 89–92.
- 6 David Huber, 'Lacaton & Vassal. Game Changers'.
- 7 Lacaton & Vassal, 'Transformation de 530 Logements, Bâtiments G, H, I, Quartier Du Grand Parc.', 2016, <https://www.lacatonvassal.com/index.php?idp=80>.
- 8 Lacaton & Vassal.
- 9 Lacaton & Vassal.
- 10 5IN4E and Lacaton & Vassal, 'Peterbos #9 Brochure'.
- 11 Jan Opdekamp and Ruben Janssens, 'The design process of Peterbos #9 - Interview I', 6 November 2018.
- 12 5IN4E and Lacaton & Vassal, 'Peterbos #9 Brochure'.
- 13 5IN4E and Lacaton & Vassal.
- 14 Opdekamp and Janssens, 'The design process of Peterbos #9 - Interview I'.
- 15 5IN4E and Lacaton & Vassal, 'Peterbos #9 Brochure'.
- 16 5IN4E and Lacaton & Vassal.
- 17 Opdekamp and Janssens, 'The design process of Peterbos #9 - Interview I'.
- 18 'BOGDAN & VAN BROECK Op Instagram: "Crossing an Urban Block! | New Set of Pictures by @jeroenverrecht"', 31 May 2019, <https://www.instagram.com/p/BylaTA0lkvn/>.
- 19 'BOGDAN & VAN BROECK', accessed 1 June 2019, <https://www.bogdanvanbroeck.com/about/>.
- 20 Vincent Degrune, 'The Brunfaut Tower. Presentation of the Conceptual Design Challenges of a Renovation.'
- 21 A229, 'Rénovation de La Tour Brunfaut. Dossier de Candidature Be.Exemplary', 7 October 2016.
- 22 'A229 - Equipe', A229, accessed 1 June 2019, <https://a229.be/equipe>.
plain-Citation": "A229 - Equipe", A229, accessed 1 June 2019, https://a229.be/equipe."; "noteIndex": 22; "citationItem": [{"id": "858", "uris": [{"http://zotero.org/users/4935074/items/4B3RBDYK"}], "uri": [{"http://zotero.org/users/4935074/items/4B3RBDYK"}], "itemData": {"id": "858", "type": "webpage", "title": "A229 - Equipe", "container-title": "A229", "abstract": "Architectes associés : Grégoire Houyet\nArchitecte - ISA St. Luc Bruxelles, Belgique - 1996 Renaud Van Espen\nArchitecte - ISA St. Luc Bruxelles, Belgique - 1996 Jaime Eizaguirre\nArchitecte - ETSAM..."; "URL": "https://a229.be/equipe"; "language": "en"; "accessed": {"date-parts": [{"2019", 6, 1}]}}]; "schema": "https://github.com/citation-style-language/schema/raw/master/csl-citation.json"}]
- 23 'Dethier Architecture', Dethier Architecture, accessed 1 June 2019, <http://www.dethier.be/fr>.
- 24 Anne Lacaton, Jean Philippe Vassal, and Frederic Druot, 'Tour Brunfaut. Definitiestudie Voor Een Rehabilitatie' (Lacaton&Vassal, March 2011).
- 25 Renaud Van Espen, 'The design process of Tour Brunfaut-Interview I', 20 November 2019.
- 26 As this is a Dutch tool, the original name is '24 ontwerprichtlijnen veranderingsgericht bouwen'. In this thesis, the English name '24 guidelines to transformable design' will be used.
- 27 OVAM, '24 Ontwerprichtlijnen Veranderingsgericht Bouwen', 2016, <http://www.ovam.be/sites/default/files/atoms/files/24%20Ontwerprichtlijnen%20veranderingsgericht%20bouwen%28upd%29.pdf>.
- 28 Wim Debacker et al., 'Design for Change: Development of an Assessment and Transitional Framework (Summary)' (Mechelen: OVAM, 2015), <http://www.ovam.be/sites/default/files/atoms/files/TWOL-Design-for-change.pdf>.
- 29 OVAM, '24 Ontwerprichtlijnen Veranderingsgericht Bouwen'.
- 30 OVAM.
- 31 OVAM.
- 32 OVAM.
- 33 'Materials Passports', BAMB, accessed 8 January 2019, <https://www.bamb2020.eu/topics/materials-passports/>.
- 34 'What Is Materials Passports', BAMB, accessed 10 February 2019, <https://www.bamb2020.eu/topics/materials-passports/what/>.
- 35 'Materials Passports'.
- 36 Charlotte Cambier, Waldo Galle, and Niels De Temmerman, 'The Relevance of Adaptable Façade Systems: An Evaluation through Scenario Planning' (13th Conference on Advanced Building Skins, Bern, 2018).
- 37 Cambier, Galle, and De Temmerman.
- 38 Valery van der Linden, 'Architects' Attitudes towards Users in Design.' (26 March 2019).
- 39 Annie Levasseur et al., 'Considering Time in LCA: Dynamic LCA and Its Application to Global Warm-

ing Impact Assessments', *Environmental Science & Technology* 44, no. 8 (2010): 3169–3174.

40 Mark Goedkoop, Reinout Heijungs, and Mark Huijbregts, 'ReCiPE 2008: A Life Cycle Impact Assessment Method Which Comprises Harmonised Category Indicators at the Midpoint and the Endpoint Level', May 2018, 134.

41 Levasseur et al., 'Considering Time in LCA'.

42 Goedkoop, Heijungs, and Huijbregts, 'ReCiPE 2008: A Life Cycle Impact Assessment Method Which Comprises Harmonised Category Indicators at the Midpoint and the Endpoint Level'.

43 Matthias Buyle, Johan Braet, and Amaryllis Audenaert, 'Life Cycle Assessment in the Construction Sector: A Review', *Renewable and Sustainable Energy Reviews* 26 (October 2013): 379–88, <https://doi.org/10.1016/j.rser.2013.05.001>.

44 'Veelgestelde Vragen - Achtergrondinformatie Ecolizer - OVAM Ecolizer', accessed 31 May 2019, <http://ecolizer.be/help>.

45 OVAM, 'FAQ - Gebruik van de Totem Tool', 24 January 2019, <https://www.totem-building.be/pages/about.xhtml>.

46 Elke Meex, 'Circulair Bouwen in Vlaanderen?' (infosession, 7 May 2019).

47 OVAM, 'FAQ - Gebruik van de Totem Tool'.

48 OVAM.

49 'Veelgestelde Vragen - Achtergrondinformatie Ecolizer - OVAM Ecolizer'.

50 NIBE, *Draagconstructies, NIBE'S Basiswerk. Milieuclassificaties Bouwproducten. I* (Bussum: NIBE research, 2011).

51 NIBE.

CHAPTER 3

TIMELINE DEVELOPMENT METHOD

3.1. TIME LINE DEVELOPMENT METHOD

For answering the research goal, a pragmatic yet versatile analysis method was developed. It reviews *design aspects*, *design phases* and *decision moments* and visualizes them on a timeline. These elements build up the timeline and are explained below. The result allows identifying key phases in the design process, etc. Thereafter this method is illustrated using the three case studies for which it was iteratively set-up and refined during the course of this research.

The proposed method combines elements of the studied design assessment methods of Meex and RIBA plan of work, and was developed further during the review of the three cases to also fit the larger scale and complexity of high-rise apartment refurbishments. This development was only possible through the discussions with the lead architects of each project. These discussions intervened with the design process in time and content, and might have influenced them. However, this approach, so-called action research, was the only way to better understand the design process and build with the architects a shared vocabulary and understanding. After all, learning by doing, i.e. experimentation, is considered a very effective and authentic way to learn and gain new knowledge.

The timeline method builds on the state of the art research methods presented in chapter 1. In order to structure the **design process**, it is broken down into two parameters. Firstly, the design process is divided into **design phases**. These phases are progress based. The second parameters are **design aspects**. These aspects refer to subjects the architects focused on during the design. The design aspects can also be chosen depending on the purpose of the analysis; in this case design for change and circularity.

DESIGN PHASES

The concept of design phases is an aspect that recurs in literature. For example, in the work of Elke Meex, she divides the design process into stages (i.e. predesign, design, building permit and execution stage). These stages are based on interviews with Flemish architects and thus on the most common private building practice in Flanders.¹

Since the timeline development in this thesis will work with larger, both public and private renovation projects, more general labels were needed to characterize the design phases. More methodological flexibility is offered by adopting the phases used in the RIBA plan of work (i.e. conceptual design, developed design, detailed design phase and execution phase)². Table 3.1 explains the design phases used for the analysis in this master thesis.

Even though the determined design phases often correspond to actual stages (e.g. competition, execution), this should not be the case for the timeline development in each project, as the timeline development method attempts to correspond to a variety of design processes. One should still be able to apply the timeline development method to analyze a project that, for example, did not go through a competition phase. It is also important to understand that the design phases are not based on exact time periods, but rather on the progress of the design. As no progress is made during periods where a project is on hold, (e.g. to wait for the acceptance of the building permit or the outcome of the competition), these periods are not taken into account for the development of the timelines.

Table 3.1: Understanding design phases, inspired by both Meex and RIBA plan of work

<p>CONCEPTUAL DESIGN PHASE</p>	<p>The main concepts are defined.</p> <p>No final choices are made yet.</p> <p>This is when the client gets his first idea of what the project will look like.</p> <p><i>This phase usually corresponds to the competition phase.</i></p>
<p>DEVELOPED DESIGN PHASE</p>	<p>More specific choices are made, like the type of structure or general choices for the materials. Usually the actors are in the possession of more information during this phase. Therefore, they sometimes review and change some choices, made in the conceptual phase, due to budget, structural restrictions, ...</p>
<p>DETAILED DESIGN PHASE</p>	<p>To make the choices, made in previous phases buildable, the building details are worked out.</p>
<p>EXECUTION PHASE</p>	<p>In preparation of the execution, detailed drawings are developed including also all technical designs. Specific choices are made about brands, materials, products, ...³</p>

DESIGN ASPECTS

As mentioned above, the second way to structure the design process is the categorization of design decisions into aspects. The aspects are chosen depending on the desired information to be received from the timeline development. In specific analysis, only one aspect could be chosen. However, by choosing different design aspects, the interactions between them could become clear, offering more nuanced information and in-depth insights.

For this thesis, five design aspects were chosen to structure the timelines of the three case studies. These design aspects are the common denominators for the three post-war high-rise cases studied in this thesis. The first one, 'Function' indicates the way the vertical and horizontal extensions of each building are planned to be used (e.g. as winter garden, terrace, thermal buffer). In each of the studied case these extensions are essential to make the buildings fit-for-purpose again. The second aspect, 'Structural design' illustrates how those extensions structurally work and what they look like. This is closely related to the third aspect: 'Material'. This aspect is common in all building projects and depending on the design phase, it focuses on structural material use, finishing materials, etc. The fourth selected aspect is the 'Inhabited construction'. As mentioned in chapter two, this concept was introduced in the projects by Lacaton & Vassal. From the interviews, it became clear that this aspect took interesting paths over the course of the case study design processes and was applicable on other projects too. The last aspect is 'Techniques' since the first review of the design proposal already indicated that including this aspect would give a more complete story on post-war high-rise renovations.

DESIGN PROCESS

Now that the main frame is set, the timelines themselves can be developed. As explained in chapter two, information on the design process can be obtained by interviewing the architects, who designed the project. This information can then be completed with information from plans and documents that were created over the course of the design process.

The timeline development method makes a distinction between gradually flowing timeline arrows and punctual decision moments.

TIMELINE ARROWS

Each **design aspect** has its own timeline. They are continuous over the design phases, becoming wider around the times when more attention was paid or research was done on the specific design aspect. Contrary to many theories on design processes, the timelines in this thesis are developed linearly.⁴ However, this model leaned the closest to the information, received from the interviews on the case studies.

Two types of transitions in thickness are indicated by the timeline. The first one is a smooth transition. This refers to a certain decision, that is studied, made and developed further or put aside for later development. The second transition is very abrupt. It usually means that a certain aspect was dropped or instantaneously implemented without further research.



Figure 1: arrow thickness transitions

DECISION MOMENTS

To indicate punctual choices, decision moments were introduced. They are usually preceded by a growing timeline and followed by a gradually decreasing one, indicating the research done to reach a decision and the further development and testing of this decision.

Decisions are characterised by an objective, influencing factors and an outcome. The objective is usually the intended result, defined by the client, the legislator or the architects themselves. Influencing factors guide the research towards the outcome, the final choice or decision. Influencing factors could be external (e.g. preferences of client, state of the existing building, budget cuts) and internal (e.g. a previously made decision).

3.2. CASE SPECIFIC TIMELINE DEVELOPMENT

In this subchapter, the timeline development method will be applied to the case studies, presented in chapter 2. Each timeline will be introduced by a small text explaining the design process, influencing factors and decisions for each design phase, followed by the timeline of the design process. A more elaborate and detailed timeline for each case study can be found in Annex.

PETERBOS #9 – 51N4E & LACATON&VASSAL

INFORMATION USED TO BUILD THE TIMELINES

Two interviews with the project architects: Jan Opdekamp and Ruben Janssens.
(full interviews can be found in annex 1 and 4)^{5 6}

plans and detailed presentations over the whole design process

The design process of the Peterbos #9 project follows the trajectory indicated by Elke Meex quite closely. However, at the moment of the interviews, the project had just handed in their building permit, meaning that they were in the beginning of the detailed design phase. Many choices in terms of detailing were not yet made.

CONCEPTUAL DESIGN PHASE

As mentioned in chapter 3.1.1, the competition phase and conceptual design phase can be linked. This was also the case for Peterbos #9. The function of the horizontal extension plays the main role in this phase. The goal of 51N4E and Lacaton & Vassal was to create a generic renovation solution for high-rise buildings with problems, similar to the ones of Peterbos #9. The main principles are largely based on the design principles of Lacaton & Vassal. However, 51N4E attempts to challenge these principles by adding an extra parameter, circularity and sustainability. However, this last argument stays rather vague in the final competition proposal.

By the end of the conceptual design phase, some assumptions are made about structure, material and techniques. Image 3.1: render of the competition project shows the first intension of the renovation, but no real decisions are made yet.



Image 3.1: render of the competition project⁷

DEVELOPED DESIGN PHASE

“[...] we took a few steps back, to look at a number of obvious decisions. That was, for example, researching whether we could make a structure that was circular. In the end, this was the biggest intervention.”⁸

The words “*circular building*” were already mentioned as a strategy in the conceptual design phase. In the developed design phase, the architects tried to find ways to make the horizontal extension in a more sustainable way. From the beginning of this phase, they also decided to work with an inhabited construction. This gave extra boundary conditions to the design of the external façade. Mainly this meant that all the elements had to be prefabricated and quickly mountable.

Four different structural scenarios were established. The structures in the scenarios are not always standard structures. Table 3.2: scenarios, influences on the scenarios and why a certain scenario was preferred to another show these scenarios along with the reasons for their particular shape. The table also shows the main reasons for why the scenarios were (not) chosen. An overall problem the architects ran into, was the lack of information and tools to make choices based on sustainability and circularity. They found it then even harder to convince their client to spend more money on a structure that was black on white not proven to have a lower environmental impact.

Table 3.2: scenarios, influences on the scenarios and why a certain scenario was preferred to another

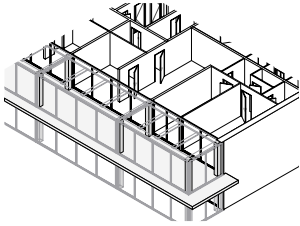
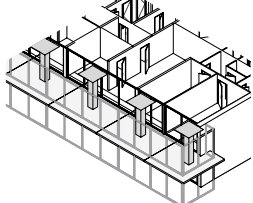
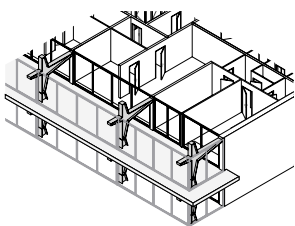
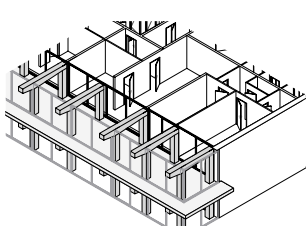
SCENARIOS	MAIN INFLUENCING FACTORS ON THE DESIGNED SCENARIOS	MAIN REASONS FOR (NOT) CHOOSING A CERTAIN SCENARIO
 <p data-bbox="181 611 475 678">OPTION 1: PREFABRICATED CONCRETE BEAMS & SLABS</p> <p data-bbox="181 719 363 748">(CHOSEN OPTION)</p>	<p data-bbox="539 376 751 405">Material usage reasons</p> <p data-bbox="539 439 855 577">Standard concrete beams are connected to concrete slabs. The concrete slabs are ribbed to use as little material as possible</p>	<p data-bbox="970 376 1190 443">Most efficient and least expensive construction.</p>
 <p data-bbox="181 981 475 1048">OPTION 2: CONCRETE MUSHROOM STRUCTURE</p>	<p data-bbox="539 763 699 792">Modular reasons</p> <p data-bbox="539 826 842 1003">A modular system of alternating prefabricated, concrete mushrooms and slabs. This system could be used as a standard for many other designs</p>	<p data-bbox="970 763 1110 792">Too expensive.</p> <p data-bbox="970 826 1222 927">Dimensions were too large for prefabrication and transportation.</p>
 <p data-bbox="181 1317 475 1417">OPTION 3: PREFABRICATED STEEL COLUMNS & CONCRETE SLABS.</p>	<p data-bbox="539 1061 708 1090">Structural reasons</p> <p data-bbox="539 1124 849 1413">To keep the foundations of the horizontal extension far away from the existing foundations, only one column carries the structure. Mass is created around the point where beam and column meet to counter the bending moment.</p>	<p data-bbox="970 1061 1225 1272">To improve the fire resistance the structure must be coated. The architects were not sure whether this would still be better for the environment.</p>
 <p data-bbox="181 1720 475 1787">OPTION 4: TIMBER BEAMS & CONCRETE COLUMNS</p>	<p data-bbox="539 1435 687 1464">Fire standards</p> <p data-bbox="539 1498 839 1637">The timber beams require to have a large diameter so they are able to stand for at least two hours.</p>	<p data-bbox="970 1435 1200 1536">“Due to large diameters, you lose the elegance of the structure”</p>

The one of the main things the architects were comparing of during the comparison in table 3.2, above, was the environmental impact of the materials used to build the structure, before their use. However, after they make the choice for concrete, attention is still paid towards whether or not option one should could still be a reversible structure. This search is put on hold because the team had to start the preparations for the building permit.

The function remains an interesting aspect of the developed design phase as well. Even though the user function was already fixed, the thermal function of the horizontal extension stayed an important research topic. The thermal regulations system in Belgium (EPB) cannot take into account the function of the winter garden as a thermal buffer. This has an impact on the material used in the detailed design phase. The insulation in the building will have the same thickness as it would have had without the winter gardens.

“Therefore [by not taking into account the buffer effect], we now have to submit the building as if there is little difference to a standard building. towards our client, we can prove with the dynamic calculations that we make an effective improvement in terms of energy consumption. In the classical [static] calculations, the building will also answer to the classical criteria. Unfortunately, the preheating buffer effect will not be taken effectively into account.”¹⁰

The buffer effect of the winter gardens is however taken into account in for the choice of the ventilation system. The chosen ventilation system, system C, takes fresh air from the exterior to interior through the winter gardens, where the air is already warmed. The heating system, on the other hand, is influenced by the choice for the inhabited construction. It is integrated into the horizontal extension. As soon as the element of the new structure is in place, the existing heating system can be demounted and be replaced by a new one.

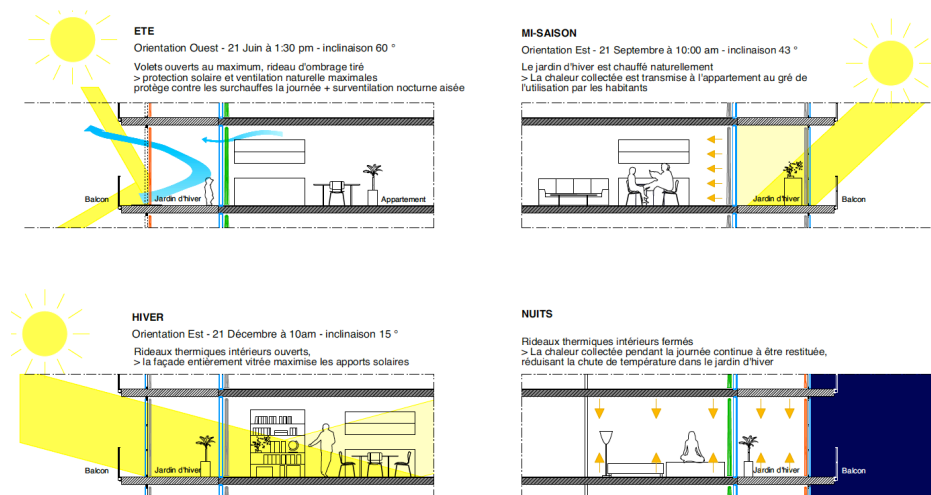

Image 3.2: The schemes show the main principles of the buffer effect of the wintergardens¹¹

DETAILED DESIGN PHASE

At the time of the interview, the architects had just started the detailed design phase. Therefore, the timeline of this case study only documents the beginning of this phase. However, they did explain the different decisions they would still have to make in the future, for example, whether the connections between the structural concrete elements would be reversible or not. A research track, they already started without making decisions yet.

CONCEPTUAL DESIGN PHASE

DEVELOPED DESIGN PHASE

DETAILED DESIGN PHASE

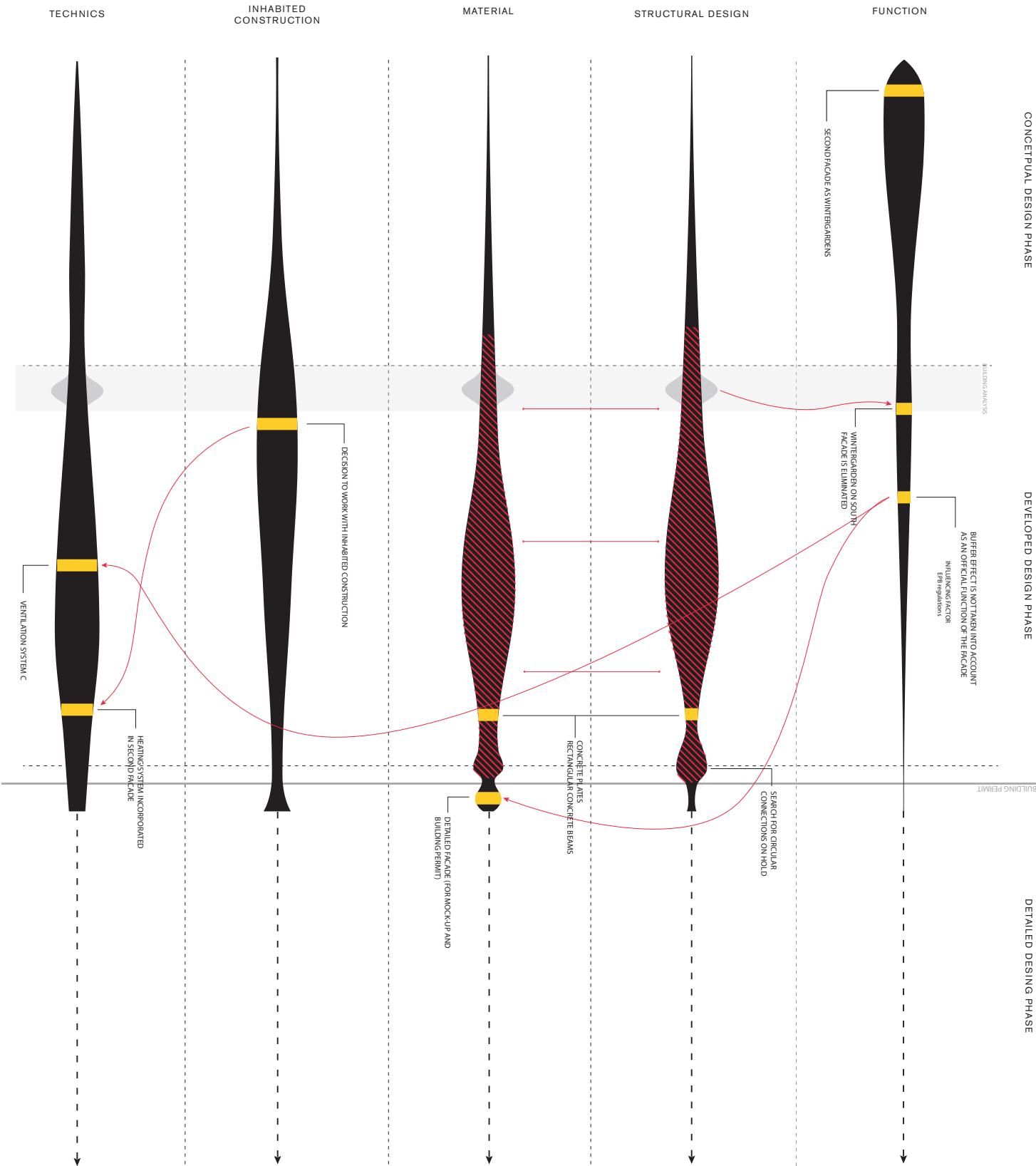

BUFFER EFFECT IS NOT TAKEN INTO ACCOUNT AS AN OFFICIAL FUNCTION OF THE FACADE INFLUENCING FACTOR EPR regulations

SECOND FACADE AS WINTERGARDENS

WINTERGARDEN ON SOUTH FACADE IS ELIMINATED

SEARCH FOR CIRCULAR CONNECTIONS ON FOLD

CONCRETE PLATES RECTANGULAR CONCRETE BEAMS

DETAILED FACADE (FOR MOCK-UP AND BUILDING PERMIT)

DECISION TO WORK WITH UNHABITED CONSTRUCTION

HEATING SYSTEM INCORPORATED IN SECOND FACADE

VENTILATION SYSTEM C

DETAILED TIMELINE
PETERBOS #9
BY STINE AND LACRONOMASSEN

The process is divided into progress based parameters, horizontal direction. In the vertical direction, the process is divided into design aspects, and narrow research along the design phases. The thickness of the arrow indicates the amount of research done, leading over a section.



Smooth transition a decision is made and worked out



Abrupt decision usually a means that an idea or aspect is dropped



Decision moment



Closely connected research



Influence

* see description

COSMOPOLITAN

INFORMATION USED TO BUILD THE TIMELINES:

Two interviews with the project architect: Lourenço Van Innis (two full interviews can be found in annex 2 and 5)^{12 13}

Detailed final construction plans

Competition plans and renders

Sketches made over the course the design process

The client had bought the -then office and hospital- building with a building permit, made by another architect. However, he wanted many changes to the design of the building. The façade had to change from red panels to white steel terraces. The hospital, located on the four bottom floors, had to be removed and replaced by two floors of offices. The others had to become residential like the rest of the tower. The client also wanted a vertical extension of three building levels. Therefore, a building permit modification was requested and granted. However, this meant that the speed of the design process was augmented.

“The evolution of these plans was very peculiar. When we passed this competition, there was actually almost no pre-design phase because the client had bought the building permit with the building. Therefore, we had to go really fast.”¹⁴

In this project, the conceptual and developed design phase passed quickly to the execution phase. The most important influencing factor in the whole design process of the cosmopolitan is the building analysis, held at the beginning of the execution phase. The structure was revealed to be in bad condition on certain levels. This influenced many choices, for example, the material choice of steel instead of concrete for the flooring of horizontal extension.

CONCEPTUAL DESIGN PHASE

In this case, the competition phase can be seen as the conceptual design phase. As in Peterbos #9, the function played the largest role in this phase. The design included a vertical as well as horizontal extension of the building. Since the client wanted a diversity of apartment sizes, the architects played with different functions they could assign to the horizontal extension. At the end of the conceptual phase, the architects propose to use the extension as winter gardens, terraces and as the vertical circulation space in duplex apartments. Not many decisions are made for the other design aspects. For the competition, the architects made renders to show their intension.



Image 3.3: conceptual render made for the competition of the cosmopolitan¹⁵

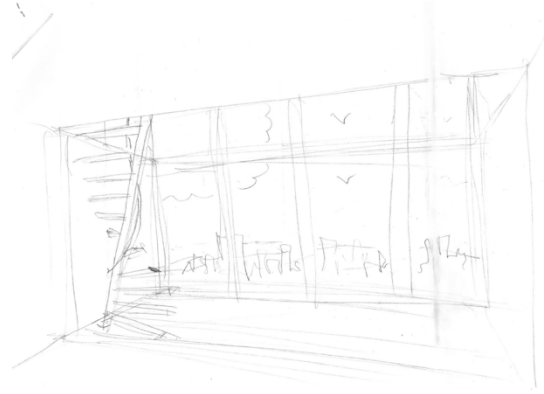

Image 3.4: interior sketch of the wintergarden serving as circulation space for duplex apartments¹⁶

DEVELOPED DESIGN PHASE

After winning the competition, the project was worked out for the permit modification. The design gets more specific as the client also influences the design from this point onwards. The functional choices are revisited and changed. Since the client was a promotor, he wanted the building to be spatially efficient. Therefore, the idea for the design of duplexes was eliminated. Later during the development phase, after many discussions with the firemen, the idea to make winter gardens proved to be complicated and expensive and was therefore canceled as well.

“Unfortunately, it [duplex apartments] is not very interesting for a promotor. Because you lose a lot of space. You have the stairs and everything inside the apartment and it is lost space. And so, we proposed that in the design phase, but in the end, for the building permit, we decided to take it out and there were no duplexes anymore.” [...] “For the winter gardens, those were even in the building permit. but in Brussels it is quite difficult to have winter gardens because of fire regulations.”¹⁷

Without any actual knowledge of the state of the building, the architects started to develop the structural system for the horizontal and vertical extension. Concrete slabs would be anchored into the existing structure. they chose concrete for its fire resistance. A non-bearing steel façade would be placed around the building to carry the balustrades and the sun protection screens. The architects, together with the client, determined the main look of the building; white steel sunshields, white steel frame to shape the terraces, aluminium windowframes, etc.

Towards the end of the developed design phase, the engineers started calculations on a ventilation system D for the building. the existing shafts would be used as their calculations confirmed that they would be large enough. Each apartment would have its own ventilation group.

DETAILED DESIGN PHASE

The choices, made in during the previous phases are designed to be buildable during this phase. The main design aspect here is the material choice. The type of insulation, flooring, facade, interior materials are all determined to match the main look appointed during the developed phase.

EXECUTION PHASE

As mentioned above, all choices before this phase were made without knowing the actual state of the building, especially of the bearing structure. The building analysis was only possible in the beginning of the execution phase. From the analysis, it became clear that the existing concrete was in really bad shape in some parts of the building. This posed problems for many choices, made in previous phases.

“what was quite complicated was that because we add three more levels, and because the building was quite old, the concrete was in bad shape. It was really of the worst and we worked with utility, stability engineers. We found solutions to reinforce the structure. So, we put “micropalen” into the foundations and we reinforced the columns in all the structures. There is even a floor, the fourth floor, where we demolished all the columns and rebuild new ones. There was a moment where the building was hanging. What we also had to do is, the central core, because the central core was not solving the bracing of the whole building when 3 extra floors were added. We had to change the core, so what we had to do was demolish the whole core and build a new one. You can think that it might have been cheaper to just demolish the whole building and build a new one, [...]”¹⁸

The horizontal extension could no longer be anchored into the existing structure and it had to become lighter. This led to the choice to build the horizontal and vertical extensions completely in steel rather than the previously chosen concrete. Since the fire resistance of steel is much lower than the one of concrete, a new solution had to be found to correspond to the fire safety regulations. The firemen were able to accept the construction if it could stand for one hour during a fire. This led to a structural system where the horizontal extension is partially self-bearing and partially carried by the original concrete structure. In case of a fire, the vertical steel structure would not be able to stay up, while the steel floors would stay stronger as they are attached to the existing concrete slabs. This is an example where the design process can be represented by the looped systems discussed in chapter one. As a design choice had to be revisited and redesigned.

During construction, it became clear that the technical shafts were not wide enough to fit all the ventilation shafts, calculated by the engineer, meaning that a recalculation had to be done. While building, the engineers noticed that they would need a ventilation unit on the roof of the building, something that was not foreseen.



Image 3.5: photograph of the built facade¹⁹

CONCEPTUAL DESIGN PHASE

DEVELOPED DESIGN PHASE

DETAILED DESIGN PHASE

EXECUTION PHASE

FUNCTION

DIVERSITY OF APARTMENTS

NO DUPLEXES

SECOND FACADE ASTERFACE
NO WINTERGARDENS

DUPLEX APARTMENTS
PARTIALLY WINTERGARDENS, PARTIALLY TERRACE

ORTHOGONAL COLUMNS AND BEAMS

THE CONCRETE SLABS ANCHORED IN EXISTING
STRUCTURE
THE STEEL FRAMEWORK TO CARRY BALCONY
AND SHADING FINISHES

EXTENSION ARE COMPLETELY IN STEEL,
THE EXISTING STRUCTURE
AND THE STRUCTURE OF THE HORIZONTAL EXTENSION

MATERIAL

CONCRETE OR STEEL
NO FINAL DECISION YET

THE MATERIALS FOR FACADE
AND FLOORING ARE CHOSEN

INHABITED CONSTRUCTION

TECHNICS

VENTILATION SYSTEM D

MECHANICAL UNIT ON THE ROOF

BUILDING ANALYSIS

BUILDING PERMIT

TIMELINE

COSMOPOLITAN

BY ROBOHAI & VAN BROECK

The process is divided into progress based parameters, horizontal direction, for the overall direction, the process is standard into design aspects, influencing the design process, the process is standard into design aspects, and narrow research during the design phases. The thickness of the arrow indicates the amount of research done, leading over a section.



Smooth transition
a decision is made and worked out



Abrupt decision
usually it means that an idea or aspect is dropped



Decision moment



Closely connected research



Influences

* see description

TOUR BRUNFAUT – A229 & DETHIER

INFORMATION USED TO BUILD THE TIMELINES:

Two interviews with the project architect: Renaud van Innis (two full interviews can be found in annex 3 and 6)^{20 21}

The application for Be.exemplary²²

Feasibility study by Lacaton&Vassal²³

Final detailed sections

Conference document Brussels heritage²⁴

What makes the design process of Tour Brunfaut different from the previous two case studies is the fact that most decisions are made in the conceptual design phase. Afterwards the architects had to make minor changes to answer to regulations, but overall nothing significant changed. The reason for this particular difference is due to the feasibility study composed before the start of the competition phase. This feasibility study contained a full building analysis, some first design proposals and main fire and energy legislations, that the architects had to keep in mind. This allowed them to create concepts that take all these issues directly into account, leaving less room for surprises in further design phases.

FEASIBILITY STUDY

As explained before, the project started with a feasibility study held by Lacaton & Vassal. Their first step was to do a thorough building analysis on nearly each design aspect. As in the building analyses of the previous case studies, the bearing structure, materials, for example the presence of asbestos, and technical installations were examined. Particularly in this building analysis, they investigated social, functional aspects as well. Lacaton & Vassal visited every apartment to check the number of residents in relation to the number of bedrooms in each apartment. This proved an irregularity in apartment occupation.

From these analyses, Lacaton & Vassal set up a list of propositions, for example, build with lightweight materials as the structure will not be able to bear more, replace technical installations, increase the apartment height if possible, but also guidelines on how much each apartment had to be enlarged and how the number of apartments could not be decreased. These propositions served as the base for the competition that followed.

CONCEPTUAL DESIGN PHASE

As in the previous case studies, the conceptual design phase and competition phase can be linked. Because of the propositions and building analysis in the feasibility study, the architects were able to develop a relatively detailed design concept during the conceptual design phase. They were able to make decisions on all five design aspects. Creating a concept where all aspects are closely linked. Therefore, this phase can be associated with the transparent layer scheme introduced in chapter one. As each decision on each design aspect is connected to the other.

To keep the same number of apartments while enlarging them, A229 proposed to add four additional floors as a vertical extension on the top of the building and a horizontal extension on the east- and west facades. The horizontal extension in Tour Brunfaut would serve as interior space and wintergardens. An insulated façade panel system would be attached to the horizontal extension. The first concept for this system can be seen in Image 3.7:

schemes made for the competition. a clear material concept is already developed. Because the existing bearing structure was not strong enough to bear the load of the extra floors, a structural concept was developed, where the vertical and horizontal extensions would work together as a bridge system. The bottom level of the vertical extension would be a structural floor that transfers the loads of the floors above to the columns of the horizontal extension. Image 3.6: the structural concept to bear the extra four level added to tour brunfaut shows the main principle of this structural concept.

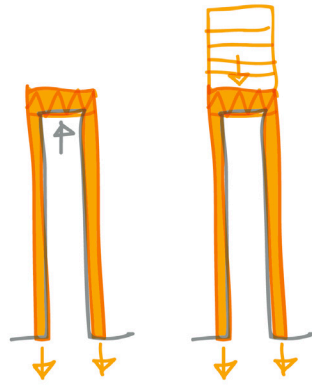

Image 3.6: the structural concept to bear the extra four level added to tour brunfaut²⁵

The fire safety laws combined with the weakness of the bearing structure and the low ceiling height, did not leave much choice in terms of structural floor material. As concrete would be too heavy and steel would not be fire resistant enough, full timber floor slabs seemed to be the best fit. The low height of the ceiling and the weakness of the building also influenced the technical concept. To prevent the load of very heavy technical ventilation and heating units on the existing structure, the installations were distributed over the building; one on the ground floor, one in the middle and one on the roof. Extra vertical ventilation shafts were installed to minimize the length of shafts that run horizontally, reducing the surface of false ceilings to keep the apartments as high as possible. For this reason, the electricity is also kept visible on the apartments ceilings. Because Lacaton & Vassal had proposed to work with an inhabited construction for this project as well, A229 had incorporated this idea into the concept as well.

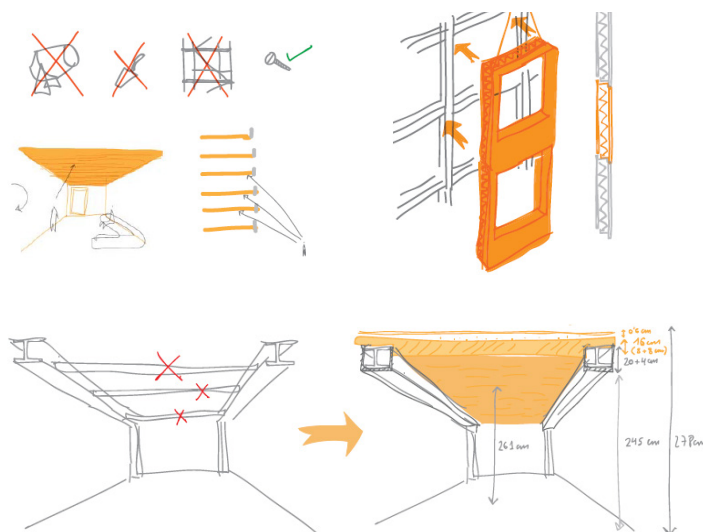

Image 3.7: schemes made for the competition. a clear material concept is already developed²⁶

DEVELOPED DESIGN PHASE

As mentioned before, the concepts were discussed with the client during the following phases, while little was changed to the design. Discussions with the client allowed for certain functions to be added while others were removed. During this phase, the architects developed the construction plan for the inhabited construction further into detail. Since Tour Brunfaut was in poor conditions, the whole interior had to be replaced. As a result, the inhabitants would not be able to stay in their apartments. They would have to move a few times during the construction works. Moreover, the whole process from the feasibility study, the competition and then the development phase had taken many years, allowing Tour Brunfaut to decay even more. Over time the social housing company had stopped replacing departing residents with new ones. The building started to become empty over time. Therefore, the client and the architects did not see the profit of making a large investment into an inhabited construction for the few residents still present in the building.

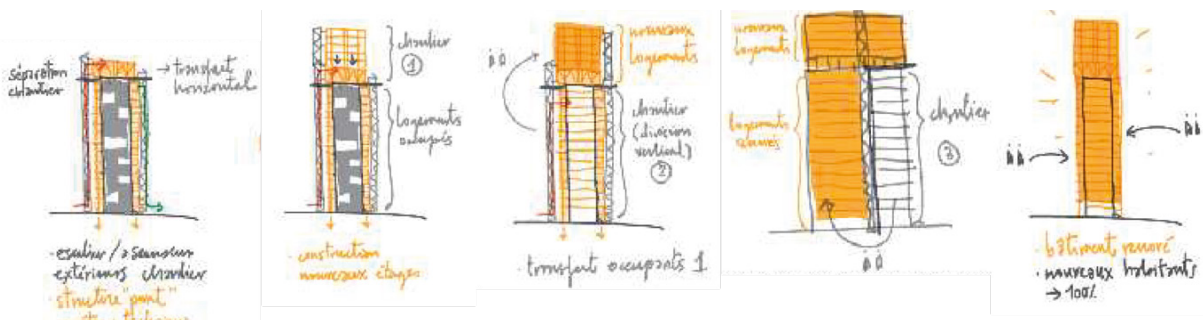
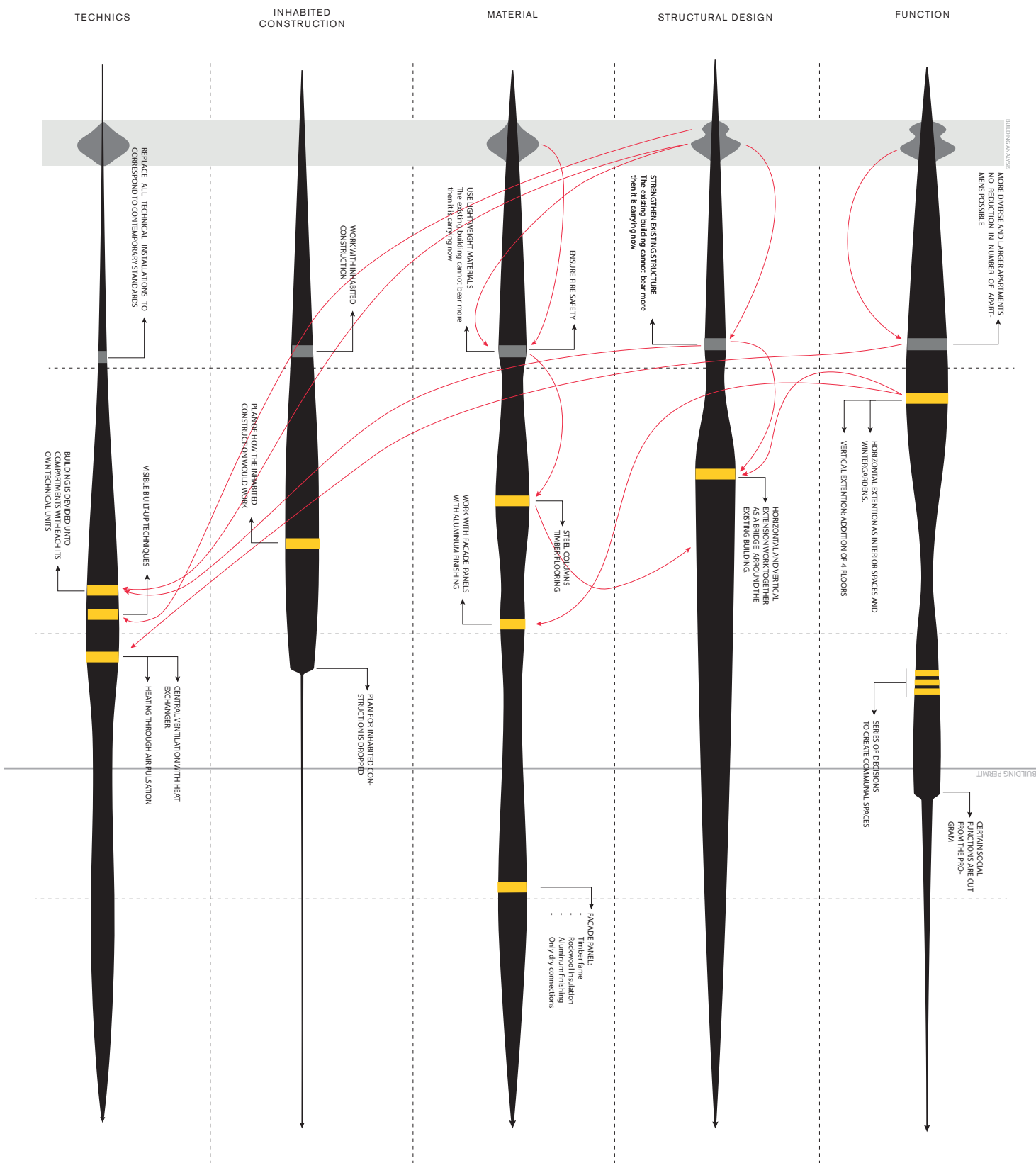

Image 3.8: scheme for the planning of the inhabited construction in Tour Brunfaut²⁷

DETAILED DESIGN PHASE

As in the previous case studies, material was the most significant design aspect in the detailed design phase. The detailed materials were chosen with the client, fire regulations and energy performance in mind. The materials chosen for the façade and floorings seem to be keeping sustainability and reversibility in mind as is explained in their candidacy for be.exemplary.²⁸



DETAILED TIMELINE
BRUNFAUT TOWER
 BY A328 AND DETRIER ARCHITECTS

The process is divided into progress based parameters, but overall direction, in the vertical direction, the process is divided into design aspects, subject to technical analysis and during the design process, each aspect has a specific role and function, and the overall process is a continuous one, or indicates the amount of research done, leading to a decision.

Smooth transition
 a decision is made and worked out

Abrupt decision
 usually it means that an idea or aspect is dropped

Decision event

suggestion

Closely connected research

Influences

* see description

3.3. RETROSPECTIVE REFLECTION AND FINDINGS

The following paragraphs describe observations made after applying the timeline method. First, some observations are made on the method itself. They indicate the weaknesses and the strengths of the method. Second, the results, found by applying this method, are explained.

RETROACTIVE REFLECTION ON THE ANALYSIS METHOD

The accuracy of the timelines is strongly depended on the information received by the researcher who develops the timelines. Because the presented timelines are based on interviews, they portray the subjective view of the project architects, based on what they could recall from previous discussions with clients and engineers. Therefore, they were only able to explain the decisions that were most important to them and the project. Furthermore, as mentioned in chapter 2, the architects were aware of the main subject of this research. This could have influenced the information provided during the interviews.

In order to build extremely accurate timelines, one must have very detailed information. One way to obtain this level of accuracy could be by following each design meeting. The topics that were discussed during the different meetings should then be added to the timeline. However, this was not possible for the creation of the timelines in this research.

The timelines in this master thesis still give a good indication of what was most important for the architects and clients throughout the design process. During the interviews, the biggest struggles and most significant solutions came forward. Therefore, these timelines should be seen as an important overview, indicating the main evolutions and decisions of a project throughout a design process.

INSIGHTS RECEIVED FROM THE METHOD

The timelines, developed in this thesis also allow to compare the process of the different projects and indicate where they differ or where they are similar. The following paragraphs compare the different design phases over the three case study projects. Further observations can be made over the whole design process such as recurring drivers, discussions and the main focusses, but also the length of the phases, the speed of the process, ... It is important to understand the dynamics in the design process to be able to evaluate whether a certain intervention in the process would have an impact.

COMPARISON OF DESIGN PHASES OVER THE THREE CASE STUDIES

Feasibility study

Although only one case study in this thesis, Tour Brunfaut, was preceded by a feasibility study, it proves to be an interesting medium to test design proposals. The study served as competition guidelines and thus as a base for Tour Brunfaut. Even in the final design, its influence is still visible.

Conceptual design phase

The main focus in this phase is usually the function as this will have a large impact on the concept and the further design of the building. The other aspects are kept in mind, but are in most cases not worked out yet. However, as mentioned above, these changes when the state of the existing building is already known (e.g. in the Tour Brunfaut).

Since this phase is linked to the competition phase, in the three case studies, the architects have the ambition to win the competition. This is when an original design tool or proposition is welcomed. However, the ambitions of this phase only reach the final design if they are proven or strong enough to convince the client. The client is usually not yet present during discussions in the conceptual design phase. The architects are only aware of their main intentions and preliminary budget. Most decisions in this phase will thus be revisited once the competition is won.

Developed design phase

In many cases this phase leads up to the submission of the building permit, or building permit modification. Therefore, the main choices for the 'final look' of the building are made here. The structural concept is worked out, as well as the main choices for the materials. The façade and interior spaces are designed and fixed as well.

The influence of legislators and clients becomes more apparent. In this phase, it is important to prove the client which aspects are the most important to invest in. The architects are chosen for the project and are able to spend more time to research certain paths. If necessary they check with legislators how the building can be adapted to meet the legal requirements like, Fire safety, budget, energy performance, ... The building becomes a realistic design that tries to answer the requirements of all the actors.

detailed design phase

For all three projects, the building permit, or building permit modification, is prepared and handed in in the beginning of this phase. This obliges the architects to elaborate further details. During the rest of this phase, architects are preparing for the execution phase. The material and techniques aspects play the largest role. Detailing of the building elements, like walls, floors and others is one of the main focusses in this phase.

execution

Even though only one case study, Cosmopolitan, had reached this phase at the time of the interviews, some interesting observations can be made in terms of predictability. One could argue that the redesign that the cosmopolitan had to go through was due to the fact that the design was made before knowing the exact state of the existing building. This is mostly true, however, not every redesign that had to be done was because of the late building analysis. The recalculation of the ventilation units for example, was done after installing and realising it did not work. Design uncertainties must always be kept in mind until the last moment of construction.

SPEED OF THE DESIGN PROCESS

The speed with which a design process progresses is often linked to external influences (e.g. existing building permits, state of the building). Receiving certain documents on different moments in the design process can have a large influence on the moment when certain decisions are taken and how fast phases flow into each other. The development of the three case studies shed light on the influence of the building permit and the building analysis. The speed and development of the design process is dependent on when these documents arise.

For example, during the feasibility study of the Tour Brunfaut, a building analysis was already done. This allowed the architects in the competition to go into more detail about

the structure and material choices compared to the other two case studies. It also meant that the difference between the conceptual design and the developed phase was minimal for this case study. An opposite situation occurs in the cosmopolitan project, where the building analysis could only be done in the beginning of the execution phase. This analysis showed that the existing structure of the building was in bad shape. Therefore, many core decisions had to be rethought.

In general, having sufficient insight into the building's condition and potential is crucial for the resulting decisions. The building analysis was in all three case studies something that largely influenced the design process. Predominantly because of structural problems with the existing structure that led to extra unforeseen costs, resulting in budget cuts, but also pushed the architects and engineers to work together on creative solutions.

The building permit on the other hand, forces architects to make decisions at a certain point in the design phase. Usually the building permit is handed in around the end of the developed design phase and the beginning of the detailed design phase,²⁹ as done in Peterbos #9. However, variations are possible and have a certain influence on the design process.

“with a building permit, you reach a moment where you suddenly have to narrow down to be able to decide on certain things”³⁰

As mentioned before, in the Cosmopolitan project, the client was already in the possession of a building permit. This allowed them to ask for a building permit modification, giving the architects a strict timeframe. Yet it was easier for the city to accept the building permit.

INFLUENCE OF THE BUDGET

In all three case studies, the budget was the main driver in each design process. It became clear very early in this research that budget is often the reason why certain decisions are made or dropped. For instance, in Tour Brunfaut, A229 had to redesign parts of the project in order to meet the client's budget (a social housing company). In Peterbos #9, the architects had the intension to design with sustainable materials and designed different structural scenarios. In the end, they were not able to convince the client to pay more for a more sustainable solution. Providing the client insight into the short- and long-term financial consequences of a design choice is one of the most important tasks. If the client has the long-term responsibility of the building or can valorise the added-value during the sale of the building, it can convince him to allocate budgets differently or do an additional investment in sustainable material use, adaptability and generality.

DIFFERENT ACTORS IN THE DESIGN PROCESS

Relationship with the client changes as the design develops, during the competition phase he gives his requirements in the briefing and is not present further in the conceptual phase. The architects are designing by themselves. Once the competition is won, the client revisits the conceptual design with the architects and starts giving feedback. He becomes an influencing actor, as he is the one who makes the final decisions. This allows the design to go into more detail and adapt even more to the client's requirements. This is also the phase where the architect can influence the client and propose him different alternatives. It is important to inform the client correctly to convince him of certain choices. Convincing the clients is one of the most important tasks as the clients make the final choices. Proving them that sustainable choices will not only lower environmental impact, but will also have other advantages as was done in Tour Brunfaut, could be one way to convince a client to

invest more.

The same evolution is true for the influence of the legislators. During the competition phase, they only give very rigid boundary conditions. After the competition is won, architects have the time to speak with them and convince them of certain choices. Convincing legislators is, however, often a hard task. For example, in Peterbos #9, the architects were not able to convince the legislators that the winter garden could be perceived as a buffer. Fire regulations is also an influencing factor that keeps coming back in all three case studies. Especially when it comes to the creation of winter gardens or the material choices. The architects of all three projects held meetings with the firefighters to discuss the matter of the fire safety with regard to winter gardens and the material use, specifically the use of steel. This influenced many decisions in the projects as can be read in the timelines in chapter 3.2.

Yet in some cases the architects were able to convince legislators. For example, in the Cosmopolitan, the legislators were not pleased with the previous building permit, so they were more eager to accept any changes that differed from the original design.³¹

For all three cases, the client was not the same person as the user. As in both the cosmopolitan and Tour Brunfaut, the users were not yet known, there was no direct contact between the architects and the users. Because Peterbos #9 will be construction on an inhabited site, it was important to involve the users in the building design. Presentations were held to keep the users of the building informed. There will also be a try-out unit on the ground floor of the building, so inhabitants can see what will happen to their apartment during the renovations. However, it is not clear whether the users had a real influence on the design process and the design itself.

HOW IMPORTANT WAS SUSTAINABILITY FOR THE ARCHITECTS?

All 3 offices showed an interest in sustainability, but each had its own view on the matter. 51N4E and Lacaton & Vassal saw social sustainability as an important factor in their design (Hence the attention for the inhabited construction). Even though circularity started as a project goal or ambition, it was not the most important one for them. Similarly, Bogdan & van Broeck approached sustainability from urban perspective. They aspired for example high rise and large apartments in the city center, close to public transport, with limited carpark lots provided. One office, A229, consciously applied circularity as a sustainability goal until the end. However, their main driver for the choices of timber floors and reversible connections was not necessarily sustainability, but rather practicality and other boundary conditions particular to the project.

The energy performance of the building was usually not specifically mentioned as a sustainable quality, but as an obvious fact. This is most likely due to the fact that energy regulations in Brussels are rather strict. One exception would be Peterbos #9, where the architects tried to convince the authorities, overseeing the energy regulations, that a winter garden serves as a buffer and improves the energy performance of the building shell.

Reusing and renovating the existing structure was in many cases seen as a sustainability aspect. However, usually this was not the only and probably also not the main reason for the reuse and renovation. Both Tour Brunfaut and the Cosmopolitan are located in an area where the buildings are not higher than five floors. Because of urban planning regulations, this would mean that, when demolishing the original building, they would not be allowed to rebuild as many stories.

The reason for not using circularity principles differed between the architects. 51N4E explained that, even though they examined many options of structure, connections and materials, they were not able to convince the client of the benefit of paying more to enhance circularity. Bogdan & van broeck did not explicitly mention why they did not apply circularity.

The possible impact of the inhabited construction on circularity principles and environmental impact cannot be neglected. As the architects wanted to limit the disturbance on inhabitants, they investigated which parts of the building are still intact and can be reused, increasing the lifespan of the materials, contrary to uninhabited constructions, where most of the elements are stripped, without any research into their condition.

“Take for example the bathrooms, there you have a shaft with technical pipes. We replace those pipes, but, if possible, we keep everything else in the room, the bath, the tiles, the finishing. As much as possible. This means that instead of replacing all eighty bathtubs, we might only replace forty. The other forty can be replaced by the client over the course of 10 to 20 years. This way we can use materials as long as possible”³²

CONCLUSION

Because the findings are based on only three case studies, no general conclusion can be drawn. However, they do give an idea of the solutions and struggles architects face while designing a post-war high-rise renovation. Renovation projects, especially of this size, can be very complex and unpredictable. Timing is crucial: the available information at the right moment can change the course of a design process drastically, so can the state of the existing building. Design is complex, external factors must meet internal ambitions, but social, spatial and economic gains can be created with circular, and thus material-wise, design choices

As all three projects were competition projects, the influence of the client is slowly introduced with little influence during conceptual phase to having to make the final decisions in the other design phases. Sustainable choices must be proven or have other advantages in order to convince the client to invest in them. Legislations, like fire safety, energy performance, have a lot of influence on the design itself, as they often dictate the shape of certain elements. Not all design ambitions are as important, and the less knowledge and certainty about its consequences, the less importance is given to a design aspect.

3.4. SELECTING KEY PHASES FOR EACH OF THE DESIGN ASPECTS

As mentioned in chapter one, the goal of this thesis is to be able to associate design tools and strategies to moments of decision in the design process. In order to do so, key phases are related to the relevant design tools and strategies presented in chapter 2. These key phases indicate a place in the design process where the tool could prove to be most effective and thus have an impact.

Pages 56 - 59 show links between phases by overlapping the different timelines of the case studies. For each design aspect, the most significant design phases are indicated by rectangles on the first page. The rectangles with thicker lines indicate the key phases. These are phases where the design aspect could have the most influence in the design. The key phases differ for each aspect. Therefore, the paragraphs on page 60 - 63 explain the key phases and how they relate to the design tools for every design aspect individually.

Key in associating design phases with the tools is to fully understand the characteristics of each design phase. Section 3.3.2 explains more in detail the similarities between the case studies for each design phase. This knowledge was used to understand which information is available in each design phase. As a design tool or strategy requires input to give an outcome, it is important. Generally, already the scope and goal of a design phase defines whether the tool could be relevant at that point in the process. Moreover, since the tools will not be the only influencing factor guiding the design decision, it is important to be aware of the other influencing factors of the decisions. They might undermine the outcome of the tool if not taken into account. The input, objectives, influencing factor and outcome of each key phase is listed to obtain an overview of the different characteristics of this key phase. On pages 60 - 63 These characteristics are linked to tools with a corresponding input or output.

EXECUTION PHASE

DETAILED DESIGN PHASE

DEVELOPED DESIGN PHASE

CONCEPTUAL DESIGN PHASE

FEASIBILITY STUDY

FUNCTION

STRUCTURAL DESIGN

MATERIAL

INHABITED
CONSTRUCTION

TECHNICS

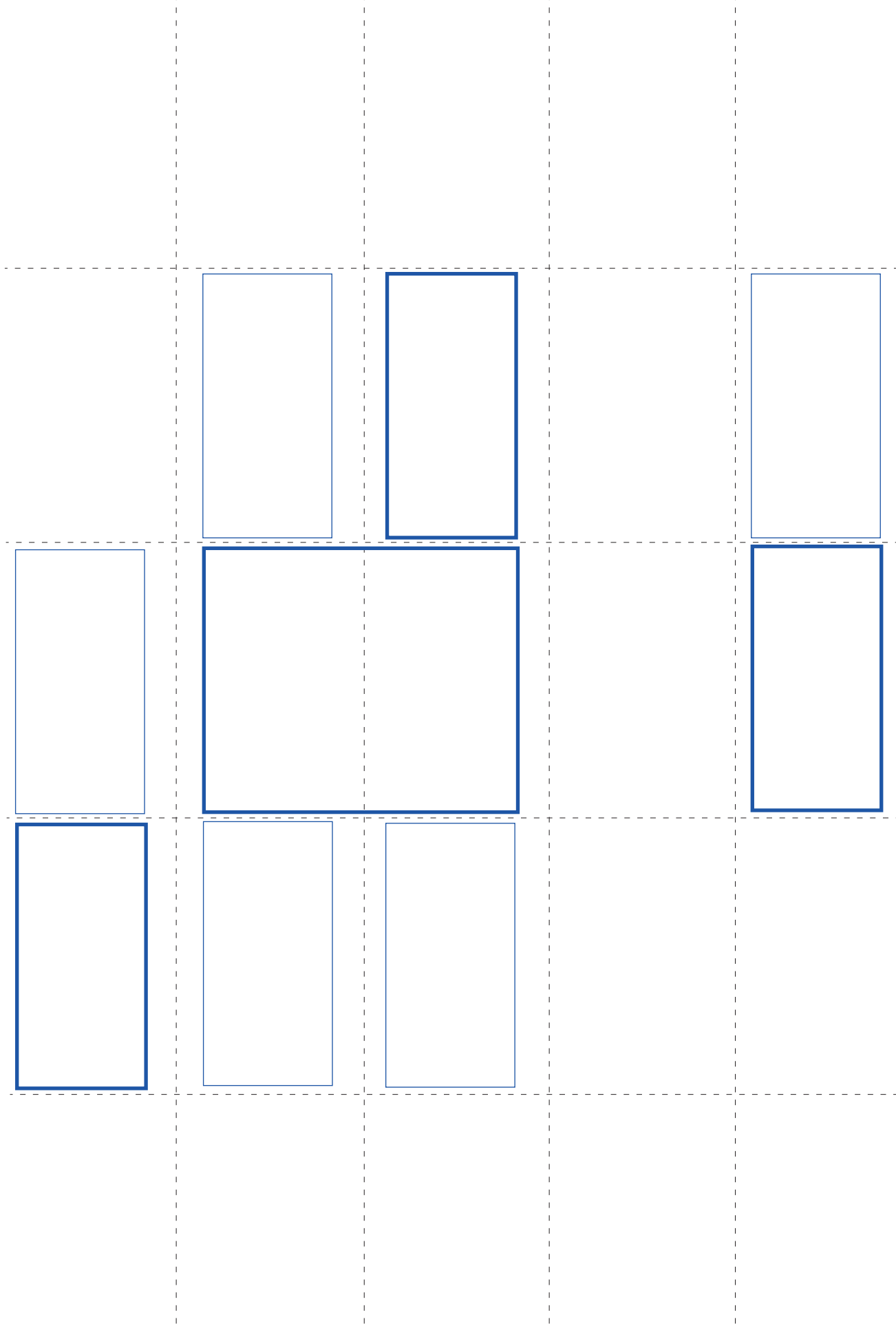

EXECUTION PHASE

DETAILED DESIGN PHASE

DEVELOPED DESIGN PHASE

CONCEPTUAL DESIGN PHASE

FEASIBILITY STUDY

FUNCTION

STRUCTURAL DESIGN

MATERIAL

INHABITED
CONSTRUCTION

TECHNICS

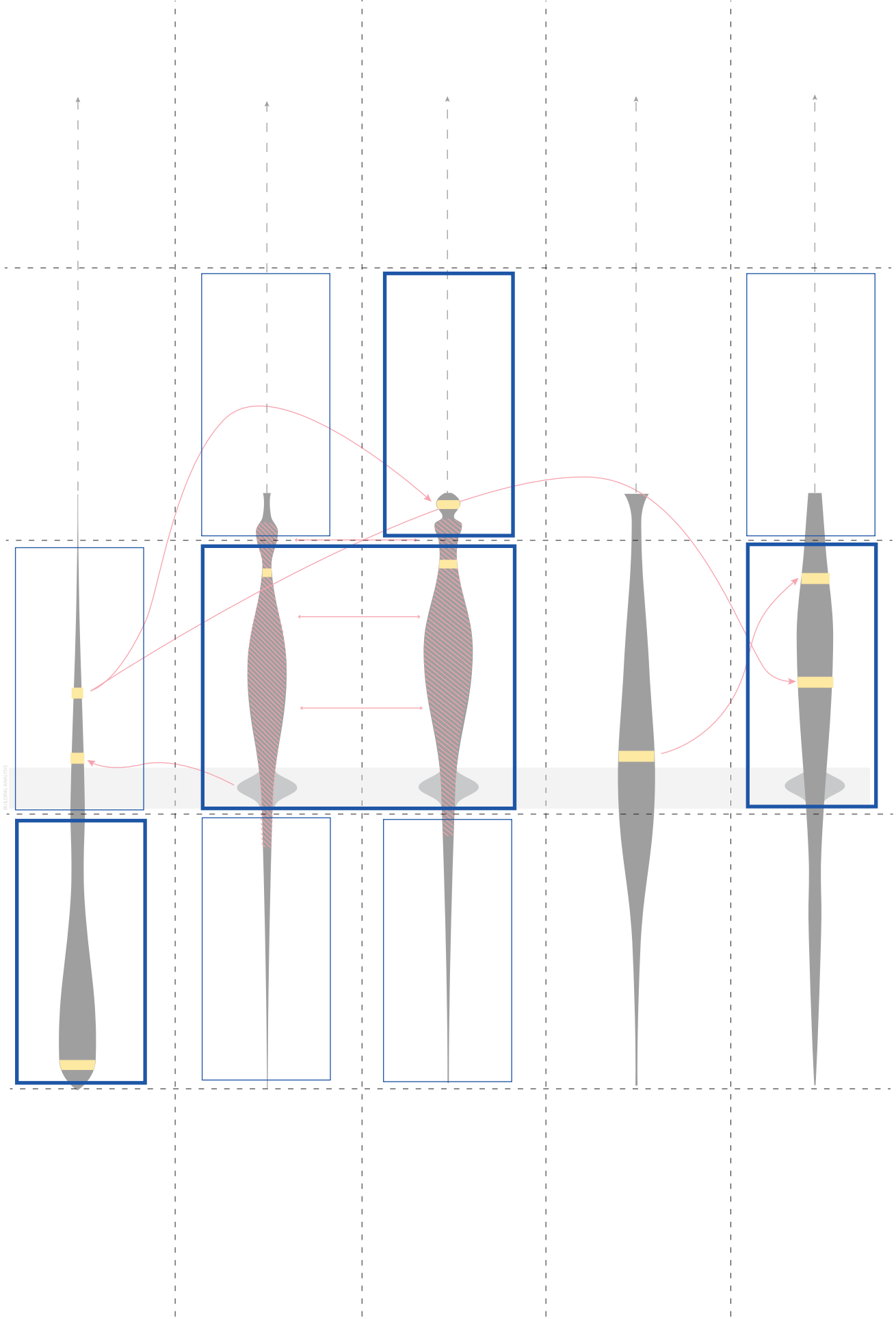

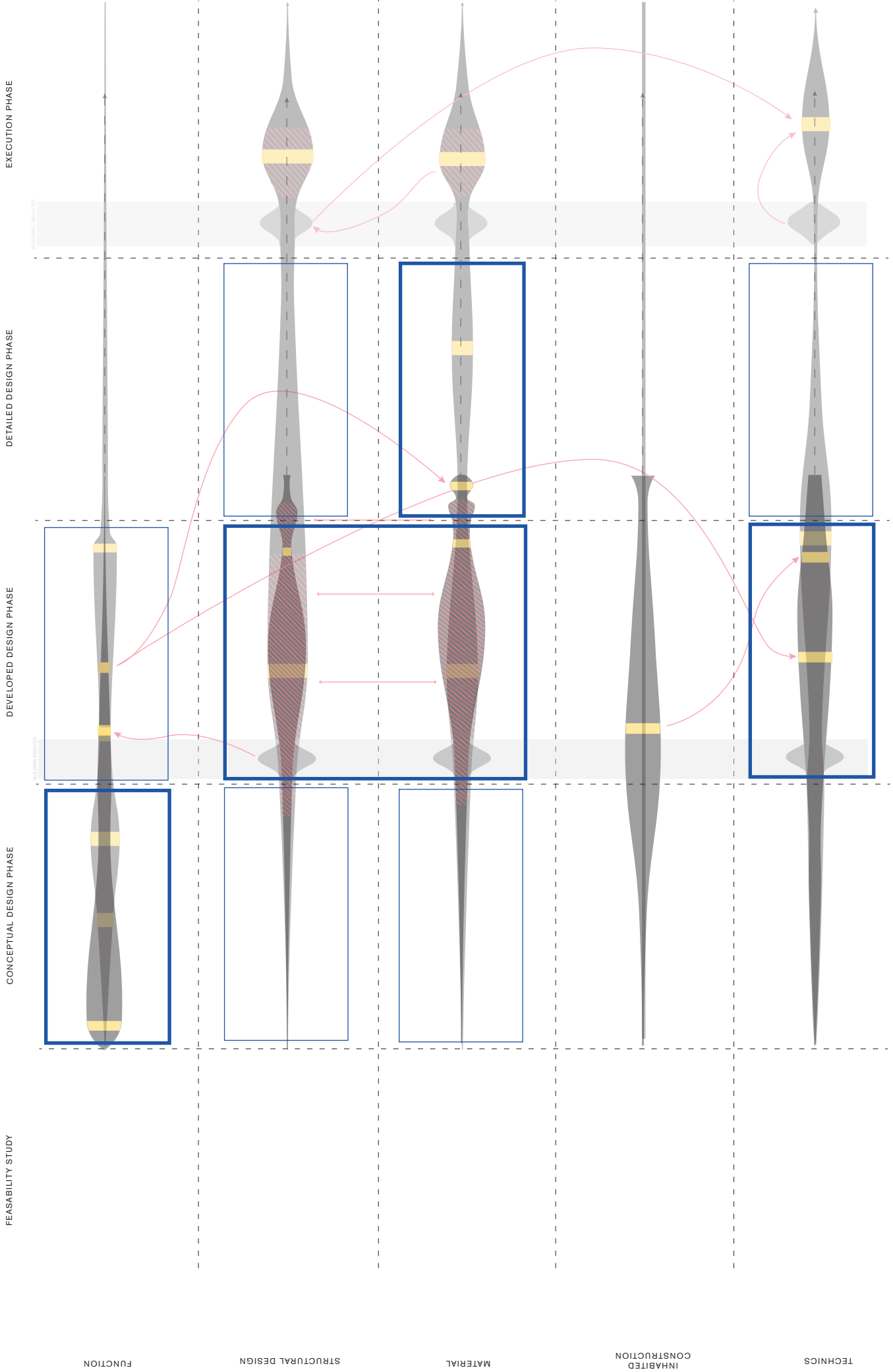

EXECUTION PHASE

DETAILED DESIGN PHASE

DEVELOPED DESIGN PHASE

CONCEPTUAL DESIGN PHASE

FEASIBILITY STUDY

FUNCTION

STRUCTURAL DESIGN

MATERIAL

INHABITED CONSTRUCTION

TECHNICS

BUILDING ANALYSIS

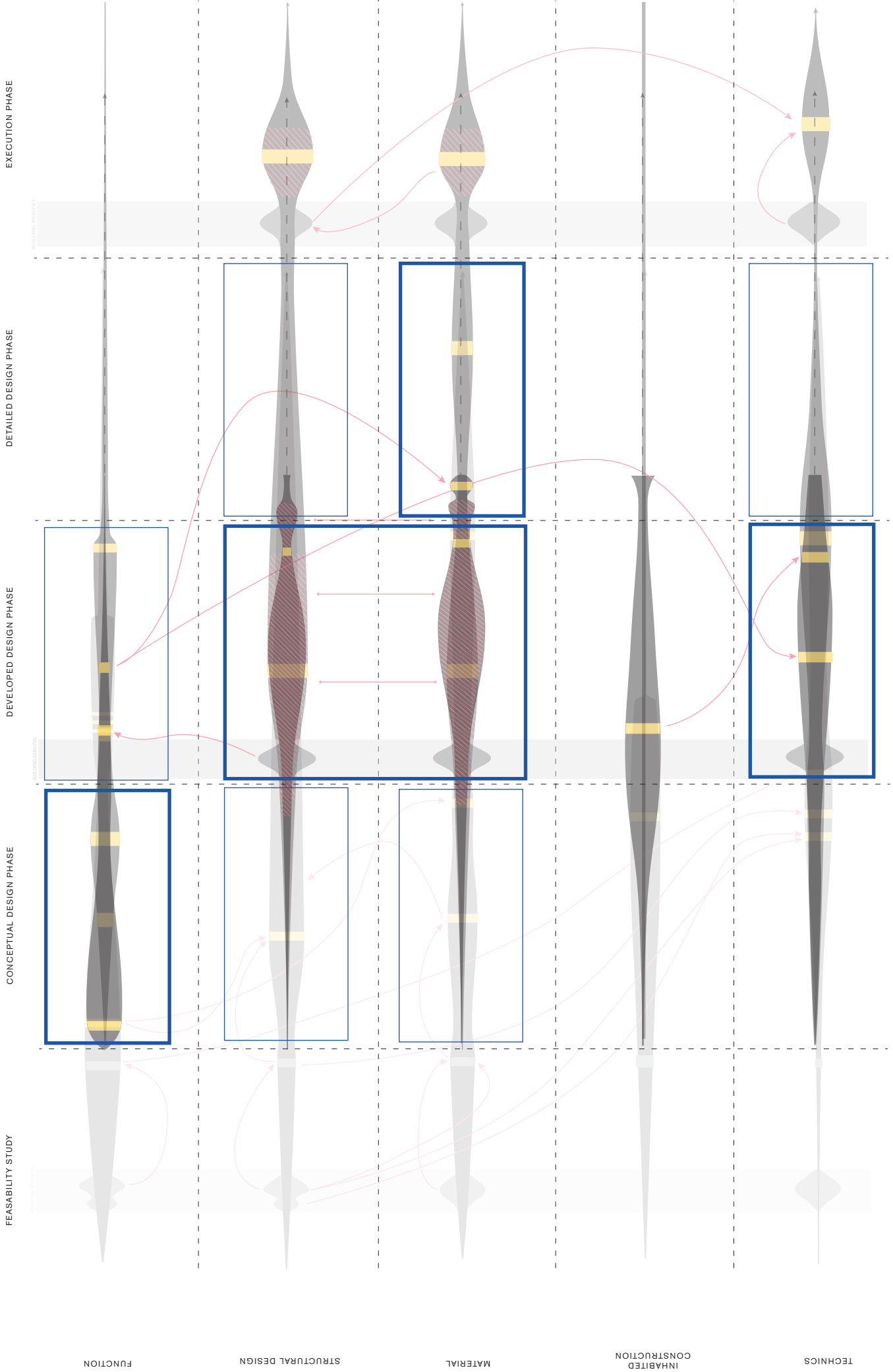

EXECUTION PHASE

DETAILED DESIGN PHASE

DEVELOPED DESIGN PHASE

CONCEPTUAL DESIGN PHASE

FEASIBILITY STUDY

FUNCTION

STRUCTURAL DESIGN

MATERIAL

INHABITED CONSTRUCTION

TECHNICS

BUILDING ANALYSIS

FUNCTION

The design aspect, function, plays an important role during both the conceptual and developed design phase. However, the most influential decisions are made in the conceptual design phase, while in the developed design phase the functional concept is worked out further and more specific decisions are taken or dropped. Determining the function in the early stages of the design will have the largest influence on the rest of the aspects, since no other design aspect is determined yet in the beginning of the design process. the function is mostly influenced by external factors as project requirements, surroundings, etc.

The main goal and outcome of the function in the conceptual design phase is to create an overall concept and determine project strategies. Applying the scenario planning strategy will help the designer to design strategies that will incorporate transformability from the beginning of the design process. the strategies will look further than just one renovation.

CONCEPTUAL DESIGN PHASE

INPUT	Project requirements proposed by the client, legislations, feasibility studies. Basic knowledge on the building itself. The more information available, the more detailed the outcome of this phase will be.
GOAL	To create the main concept of the design. In many cases, the goal is to win the design competition as this phase can be linked to the competition phase. This results in a contest for originality.
INFLUENCING FACTORS	Project requirements Ambitions of the architects
OUTCOME	First concept on one or more aspects. Project strategies

SCENARIO PLANNING

INPUT	Scenario planning should be introduced when the main concepts are determined, but the design (i.e. wall placement, facade design) has not yet started.
OUTCOME	Scenario planning can help to define project strategies In itself it does not ensure an adaptable building nor does it mean that less waste will be produced during a possible reconversion. However, it does open the mind of the architects and allows them to imagine which building elements should be adaptable (e.g. interior walls) or which elements should be over dimensioned (e.g. technical shafts). Scenario planning can also improve communication with the client, as it gives a clear image of why a certain investment is worth making.

STRUCTURAL DESIGN

Research on structural design is done throughout the whole design process, however, the most significant decisions are made during the developed design phase. The reason for this can be appointed to the fact that the structural design has to answer to internal influencing factors as, for example, the main function or the choice for inhabited construction. Furthermore, this design aspect is closely linked to the material aspect, as each structural material will need a different structural design. Therefore, the developed design phase is chosen as a key phase for both the material and structural design. In this key phase tools will be appointed to both design aspects at the same time.

Even though certain criteria in the 24 guidelines to transformable can advise on the structural design, the dimensions, system and connections depend mostly on the

DEVELOPED DESIGN PHASE	
INPUT	Main concepts wishes of the client, engineer and legislator
GOALS	Design of the optimal and efficient structure Convince client of certain choices.
INFLUENCING FACTORS	Laws: fire safety, energy performance, Budget Esthetics The client's preferences structural system and state of the existing building calculations by the engineer
OUTCOME	Structural concept with final structural material choice Dimensions of all the structural elements

chosen structural material. In most cases the structural material is one of the materials that is used in the largest quantities. Therefore, checking the environmental impact of this material thoroughly and using this information to make better informed choices, could make a difference in the overall environmental impact of the building. During the developed design phase, could design different structural scenarios without going too far into detail, as done in Peterbos #9. It is important that checking different scenarios can go fast and give a clear answer. Being able to prove which scenario has a lower environmental impact will also help architects to give better arguments to convince a client of a certain scenario. The *ecolizer* and NIBE environmental classification system could both answer to these criteria.

24 GUIDELINES TO TRANSFORMABLE DESIGN - BUILDING	
INPUT	The building level requires information about the main goals of the client. Basic information of the existing building (in case of a renovation)
OUTCOME	Making design choices while following the guidelines will allow the architect (or urbanist) to design a building that can react to future changes in function, interior, exterior... It could also help to answer questions as what will the facade look like? What type of bearing structure will be used and how will it interact with the interior spaces?

* certain guidelines can help to define the structural and technical concept as well

NIBE environmental classification	
INPUT	To use NIBE classification system information should be given about the materials the designer wants to use in the project. For certain products, the tool requires information about the function of project and minor structural choices.
OUTCOME	The user will be able to trace the environmental class of the product. He will also be aware of the specific environmental impact of this product. This will allow him to compare different materials and make better informed choices.

ECOLIZER	
INPUT	The Ecolizer requires the user to know or estimate the amounts of each material in a project and how these materials are processed before their use.
OUTCOME	The user will receive an environmental impact score. Calculating scores for different materials and how they are processed, allows the designer to compare and make better informed choices. This can help when choosing the main materials used in a design.

MATERIALS

As mentioned above, the developed design phase will be chosen as a key phase for both materials and structural design. Since material choices have large effects on the environmental impact, it is important to look at materials over the course of different phases.³³ Therefore, the detailed design phase is also appointed as a key phase for the material aspect. The choice of materials is influenced by both external factors (e.g. legislations, fire safety, budget) but also internal factors (e.g. functional choices, correspondence to the designed look of the building).

Once a design reaches the detailed phase, more precise information can be provided to the tools are available to test the environmental impact of the design. In a tool like Torem, the different wall or flooring layers build-up can be tested. NIBE can give information on the environmental impact of each material separately, While the 24 guidelines to transformable design on element level allow architects to evaluate the transformability of their details.³⁴

DETAILED DESIGN PHASE

INPUT	Building design, Floorplans, main look, indication of main visible materials, Legislations
GOALS	Make the building proposal buildable. Prepare for construction. To be aware of the exact materials that will be needed to construct the building
INFLUENCING FACTORS	Available materials and the type of connections between them. Esthetics of the building Laws: energy performance, fire safety Budget
OUTCOME	Building design is ready for execution. Most materials are chosen, structural system and connections are worked out.

24 GUIDELINES TO TRANSFORMABLE DESIGN - ELEMENT

INPUT	This level could/should be consulted once the main design is drawn and the detailing should be elaborated.
OUTCOME	Making design choices while following the guidelines will allow the architect (or urbanist) to design building elements that can be changed and reused over time. It will also ease the replacement and removal of components in the elements without damaging any materials.

TOTEM

INPUT	Torem requires the user to be able to indicate specific building element setups. The amount of each material in the building has to be known to obtain relevant results.
OUTCOME	The user will receive an environmental impact score. Comparing different scores can help the user to on which specific material to choose.

NIBE environmental classification

INPUT	To use NIBE classification system information should be given about the materials the designer wants to use in the project. For certain products, the tool requires information about the function of project and minor structural choices.
OUTCOME	The user will be able to trace the environmental class of the product. He will also be aware of the specific environmental impact of this product. This will allow him to compare different materials and make better informed choices.

INHABITED CONSTRUCTION

The decision to work with an inhabited construction is usually chosen in the beginning of a design in the conceptual design phase or at the very beginning of the developed design phase. It is only over the course of the developed design phase that it starts to influence other aspects or is completely eliminated. As explained above, the decision to work with an inhabited construction can be seen as a sustainability strategy in itself that can influence architects to do more research in what can and can't be reused. It will therefore not be linked to reversible design tools or strategies.³⁵

TECHNIQUES

In all three case studies, most decisions on techniques are taken during the developed design phase. It was only in Tour Brunfaut that a technical concept was already determined during the conceptual design phase.³⁶ Defining technical concepts in the beginning could be an interesting way to incorporate technical aspects better into the design, instead of adding them afterwards as is often the case in design projects.³⁷ However, the technical choices are often influenced by internal factors as for example, the inhabited construction, whether winter gardens will be attached to the facades. Therefore, it is not always convenient to work on a technical concept from the start of the design. The tools to design technical concepts for buildings are not in the scope of this master thesis. Making informed choices on technical concepts could, however influence the environmental impact of a building. the scheme on page 56 shows a possible and interesting key phase for these tools.

EINDNOTEN

- 1 Elke Meex, Elke Knapen, and Griet Verbeeck, 'Case Study Analysis of the Material Selection Process during Dwellig Design in Flanders', n.d., 10.
- 2 RIBA, 'RIBA Plan of Work' (RIBA, 2013)
- 3 Meex, Knapen, and Verbeeck.
- 4 Bryan Lawson, *How Designers Think: The Design Process Demystified*, 4. ed (Amsterdam: Elsevier/ Architectural Press, 2006).
- 5 Jan Opdekamp and Ruben Janssens, 'The design process of Peterbos #9 - Interview 1', 6 November 2018.
- 6 Jan Opdekamp and Ruben Janssens, 'The design process of peterbos #9 & discussion design for change assessment tools - Interview 2', 9 May 2019.
- 7 51N4E, 'Peterbos #9 - Presentations' (October 2018).
- 8 "[...] een paar stappen tergezet, zoals we ook met Peterbos gedaan hebben om eigenlijk te kijken van je hebt een aantal voor de hand liggende beslissingen die je kan nemen. Dat was bijvoorbeeld het onderzoeken van de structuur en of we die circulair konden maken. Dat was uiteindelijk de grootste ingreep." Jan Opdekamp and Ruben Janssens, 'The design process of peterbos #9 & discussion design for change assessment tools - Interview 2'.
- 9 "[...] dan moet je overdimensioneren, waardoor je de slankheid van je structuur kwijtgeraakt" Opdekamp and Janssens, 'The design process of Peterbos #9 - Interview 1, 1'.
- 10 "Het gevolg daarvan was, dat we nu het gebouw gaan aangeven dat weinig anders is dan een gewoon gebouw. Maar naar onze klant toe kunnen we naar onze klant toe, wel aanduiden, met die dynamische berekening, wat eigenlijk de effectieve verbetering is op het vlak van energie verbruik. Zelfs in de klassieke berekening, voldoet het gebouw aan de klassieke eisen. Het jammer is gewoon dat de voordelen van die voorverwarming niet effectief in rekening worden gebracht." Opdekamp and Janssens, 'The design process of Peterbos #9 - Interview 1'.
- 11 51N4E, 'Peterbos #9 - Presentations'.
- 12 Lourenço van Innis, 'The design process of the Cosmopolitan - interview 1', 19 November 2019.
- 13 Lourenço van Innis, 'The design process of the Cosmopolitan & discussion on design for change assessment tools - interview 2', 2 May 2019.
- 14 Lourenço van Innis, 'The design process of the Cosmopolitan - interview 1'.
- 15 Bogdan & Van Broeck, 'Cosmopolitan. Competition Proposal', January 2014.
- 16 Bogdan & Van Broeck, 'Cosmopolitan - Concept Sketches', January 2014.
- 17 Lourenço van Innis, 'The design process of the Cosmopolitan & discussion on design for change assessment tools - interview 2'.
- 18 Lourenço van Innis, 'The design process of the Cosmopolitan - interview 1'.
- 19 'BOGDAN & VAN BROECK Op Instagram: "Crossing an Urban Block! | New Set of Pictures by @jeroenverrecht"', 31 May 2019, <https://www.instagram.com/p/BylaTA0lkvn/>.
- 20 Renaud Van Espen, 'The design process of Tour Brunfaut - Interview 1', 20 November 2019, 1.
- 21 Renaud Van Espen, 'The design process of Tour Brunfaut & discussion on design for change assessment tools - Interview 2', 6 May 2019, 2.
- 22 A229, 'Rénovation de La Tour Brunfaut. Dossier de Candidature Be.Exemplary', 7 October 2016.
- 23 Anne Lacaton, Jean Philippe Vassal, and Frederic Druot, 'Tour Brunfaut. Definitiestudie Voor Een Rehabilitatie' (Lacaton&Vassal, March 2011).
- 24 Vincent Degruene, 'The Brunfaut Tower: Presentation of the Conceptual Design Challenges of a Renovation.' (The energy future of existing buildings in Brussels: between preservation and performance, Brussels: Brussels urban development, 2014), 89-92.
- 25 A229, 'Rénovation de La Tour Brunfaut. Dossier de Candidature Be.Exemplary'.
- 26 A229, 'BRUNFAUT Réhabilitation et Rehausse de La Tour Brunfaut de 97 Habitations Sociales Molenbeek, 2013', A229, accessed 2 June 2019, <https://a229.be/post/74265830584/brunfaut-r%C3%A9habilitation-et-rehausse-de-la-tour>.
- 27 A229.
- 28 A229, 'Rénovation de La Tour Brunfaut. Dossier de Candidature Be.Exemplary'.
- 29 Elke Meex, 'Early Design Support for Material Related Environmental Impact Assessment of Dwellings' (Doctoral Thesis, UHasselt, 2018), <https://uhdspace.uhasselt.be/dspace/handle/1942/27512>.
- 30 "bij een bouwvraag heb je een moment waar je opeens moet vernauwen om een aantal dingen vast te leggen, kleuren en materialen" Jan Opdekamp and Ruben Janssens, 'The design process of peterbos #9 & discussion design for change assessment tools - Interview 2'.
- 31 Lourenço van Innis, 'The design process of the Cosmopolitan & discussion on design for change assessment tools - interview 2, 2'.
- 32 "Wat we eigenlijk gezegd hebben is van kijk, je hebt een appartement. Daar is een badkuip, en een schacht met technische leidingen. Deze leidingen in de schacht, die vervangen we. De badkuip, de betegeling en de afwerking, die behouden we. Zo veel als mogelijk. En we zeggen, in plaats van nu all de 80 badkuipen over het appartement te vervangen, gaan we er nu 40 vervangen. En die andere 40, die kan de klant in de loop van de 10 a 20 jaar zelf vervangen. De keuze om de materialen zo lang mogelijk te behouden." Jan Opdekamp and Ruben Janssens, 'The design process of peterbos #9 & discussion design for change assessment tools - Interview 2, 2'.

- 33 Meex, Knapen, and Verbeeck, 'Case Study Analysis of the Material Selection Process during Dwellig Design in Flanders'.
- 34 OVAM, '24 Ontwerprichtlijnen Veranderingsgericht Bouwen', 2016, <http://www.ovam.be/sites/default/files/atoms/files/24%20Ontwerprichtlijnen%20veranderingsgericht%20bouwen%28upd%29.pdf>.
- 35 Jan Opdekamp and Ruben Janssens, The design process of peterbos #9 & discussion design for change assessment tools - Interview 2.
- 36 Renaud Van Espen, The design process of Tour Brunfaut & discussion on design for change assessment tools - Interview 2, 2.
- 37 Lourenço van Innis, The design process of the Cosmopolitan & discussion on design for change assessment tools - interview 2.

CHAPTER 4

PROOF OF POTENTIAL

In the previous chapter, key phases for each of the discussed design aspects were appointed to reversible design tools and strategies. This chapter will illustrate the potential of a design tool by applying it on each case study in the assigned key phase. This will result in one alternative design for each case study. It is important to realize that the succeeding of a design tool does not solely depend on the phase in which it is applied. The type of project and the opportunities it presents also have an influence on the potential of the tool. Therefore, the key phases and tools in this chapter are also chosen with the best tool possible in mind. Table 4.1 gives an overview of the key phases and tools illustrated in this chapter. After applying the tools, the research results were presented to the architects of each case study to spark a discussion between practice and theory.

Table 4.1: overview of the key moments, tools and case studies that will be discussed in the following chapter.

KEY PHASES	KEY PHASE 1	KEY PHASE 2	KEY PHASE 3
DESIGN ASPECT	Function	Material and structural design	Material
DESIGN PHASE	the conceptual design phase	the developed design phase	the detailed design phase
DESIGN TOOL	Scenario planning	Ecolizer & NIBE environmental classification	24 guidelines to transformable design (on the element level)
CASE STUDY	Cosmopolitan	Peterbos #9	Tour Brunfaut
REASON FOR APPLYING THE TOOL TO THE CASESTUDY	<p>With its open floorplan, the existing cosmopolitan building shows a high transformable capacity. There is a significant potential to perform a renovation that will still be flexible for future transformations.</p>	<p>As explained above, the architects of Peterbos#9 already created different structural scenarios that they wanted to compare based on environmental impact. However, they were not able to prove in a simple way, why one scenario would be better than the other. It would thus be interesting to see whether the Ecolizer and/or NIBE could provide this desired proof.</p>	<p>The façade and floor materials and connections in Tour Brunfaut were done with keeping reversibility in mind. It is therefore interesting to see where they did not choose a reversible connection or durable material and why.</p>

4.1. KEY-MOMENT I: FUNCTION - THE CONCEPTUAL DESIGN PHASE – SCENARIO PLANNING - COSMOPOLITAN

Scenario planning could be an interesting strategy to implement in this phase of the design. When applying this strategy, the designer has to take into account the future modifications that could happen to the building in terms of demographic changes, household diversity, but also different functions. Scenario planning also supports architects in convincing their clients of a certain principle or design choice. The client will get a clear image on the benefits and the reason why a larger investment in certain solutions could be beneficial.¹

Two parameters have to be taken into account. The first one is the possible transformations the building might go through, when, for example, the function, surroundings or owner of the building changes. The second parameter is the rate of change. How fast might the building change over time? A fictional scenario, based on realistic possibilities is set up in the following first two paragraphs. Afterwards, the implications of this scenario on the design of the cosmopolitan will be evaluated.²

SCENARIO PLANNING ILLUSTRATED ON THE COSMOPOLITAN

WHY COULD A CHANGE IN FUNCTION TAKE PLACE?

The cosmopolitan was designed as an office building with an open plan. The building shows a lot of flexibility, because there are hardly any internal walls. It already hosted different functions over the years (e.g. hospital on the bottom four floors with offices on the rest of the floors). This renovation by Bogdan & Van Broeck also altered the function from offices to housing. A future shift in function could thus be a possibility. Especially since the central location of the Cosmopolitan makes it a place that might have to react to the needs of the large population living in the centre of Brussels.³ Large populations bring different needs, for example; Hospitals, schools, etc. Currently Brussels suffers from a lack of primary schools. According to Estimates, this will only get worse due to the population growth⁴. To answer to this problem, it could be possible that over time a conversion of this building, or part of it, into a school might take place. The possible scenario, where the cosmopolitan would transform into a school building, is used throughout this illustration.

DOES THE COSMOPOLITAN ANSWER THE REQUIREMENTS TO BECOME A SCHOOL?

A first step to a valuable scenario is to check whether the proposed scenario(s) could be possible in terms of size, plan set-up, ... The following paragraphs evaluate the cosmopolitan by comparing it to the requirements for a school determined by Aline Vergauwen in her master thesis, *“A design strategy for the transformation of vacant office buildings into schools”*. Table 4.2 shows this comparison.

Table 4.2: requirements to be suitable as school building⁵

	REQUIRED	IN COSMOPOLITAN
FLOOR-TO-FLOOR HEIGHT	Min. 310 cm	380 cm
RATE OF CHANGE IN THE INTERIOR FITTING-OUT	Free plan layout	Free plan layout
OUTDOOR SPACE	Connection to outdoor space is necessary	Limited outdoor space on the ground floor next to the building⁶
HEATING AND COOLING	Building should have a high thermal mass to facilitate cooling of the building. Cooling system is an advantage.	Original thermal performance of the building did not respond to current requirements. Energetic renovations had to be done no matter the future building function. ⁷
TECHNICAL SHAFTS	Spacious technical shafts are required according to the regulations.	4 central shafts, 1 shaft on each end of the building. ⁸
VERTICAL CIRCULATION	Building should have an adequate number of expansive vertical shafts, or the possibility to add shafts without costly adaptations to the structure.	4 central elevators, 2 staircases one central and one at the end of the building. ⁹
STRUCTURAL ASPECTS	The building should have a structure that has a high load-bearing capacity. Overdesigned structural elements (like beams, columns and foundations, ...) are advantageous.	The concrete bearing structure was in bad conditions. So, the bearing capacity of the building was limited.¹⁰
FIRE SAFETY	The office building should have a sufficient number of well positioned staircases and exits. Accordign to Belgian fire safety laws, a person in a High-rise building cannot be further then 30m away from an escape staircase. ¹¹	Both staircases are within the evacuation distance of 30m from every point in the building. ¹²

When comparing the requirements stated by Aline Vergauwen to the cosmopolitan building. It becomes clear that only two aspects do not meet the qualifications. As a school requires a sports hall the high-rise building should be strong enough to bear this function. After the building analysis, it became clear that the strength of the existing building did not even suffice to bear the planned three extra levels. A solution to this problem could be to create a bridge like structure as the system in Tour Brunfaut. Moreover, it is always beneficial from a transformability point of view to over-dimension a building no matter the envisioned possible future. The structural level created by the bridge system could serve as the school's playground to solve the second problem

derived from the comparison with the school requirements. Image 4.1 shows a possible scenario where the top six floors of the Cosmopolitan would host a primary school.

It must also be kept in mind that, in this case study, the weak state of the existing bearing structure had only come to light during the building analysis at the beginning of the execution phase. Even if the architects would have used the scenario planning strategy in this way, they would not have been able to foresee the fact that their building would be too weak to carry a sports hall.

It is not always necessary to make such drastic changes to alter the function from residential to educational. A learning centre for adults or young adults in the cosmopolitan would not need this sports hall nor the large playground. It could be sufficient to change the walls of a few floors in order to create classroom spaces. Another option could be to imagine that the fictional primary school would not have its own sports hall, but instead use the existing

sports infrastructure in the surroundings, owned by the city.

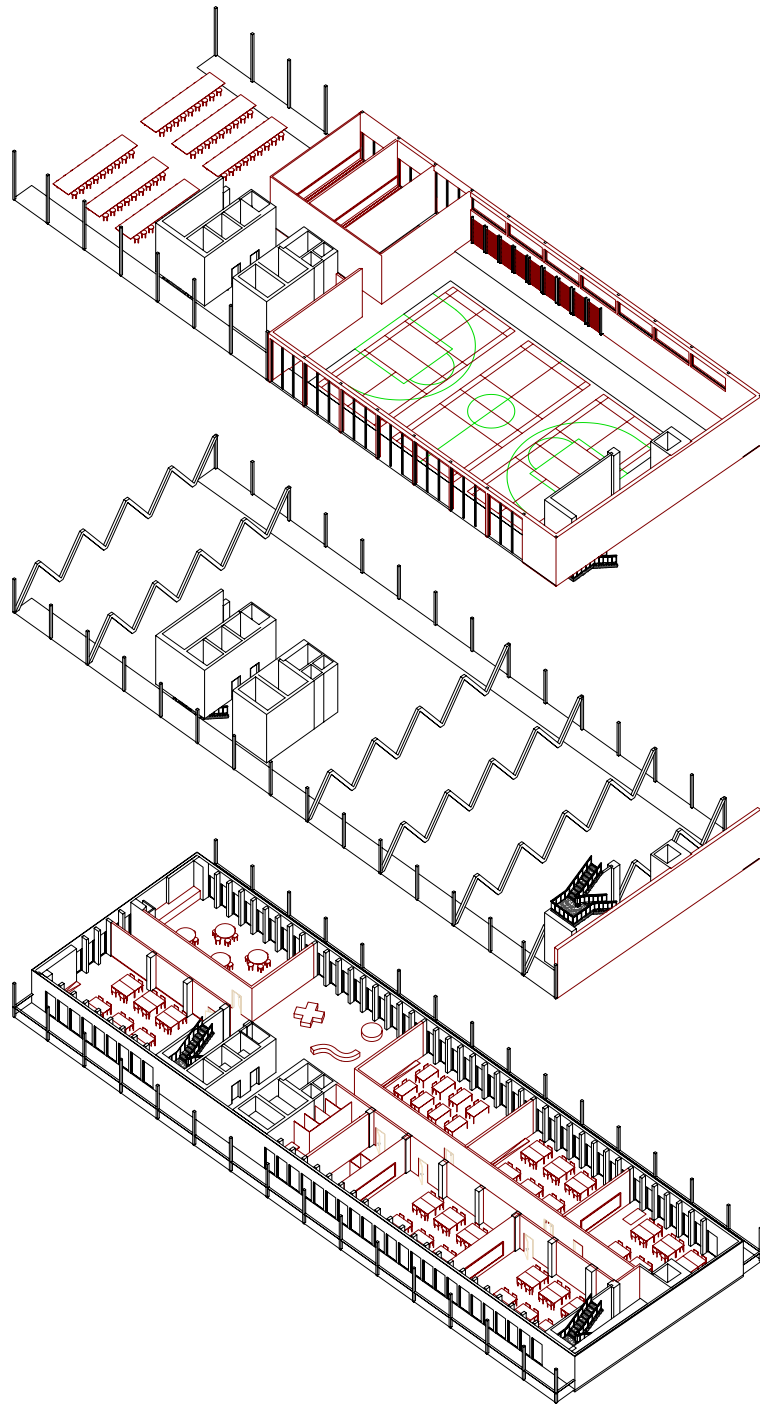

Image 4.1: possible layout for an abrupt conversion of the top floors into a school

RATE OF CHANGE

As mentioned in chapter two, the rate of change is the second important parameter, when applying scenario planning. In this case three change rates are defined; no change, gradual conversion and abrupt change. Adding the rate of change to the reconversions of the previous paragraphs can help to understand which parts of the building should be transformable and or not transformable at all. It can also help to see which elements should not be transformable at all. Three possible time-based scenarios are sketched to give an idea on how fast the change could happen and what could be the consequences.

NO CHANGE

In this scenario, the building will keep the same function throughout its lifespan. However, one must still take into account the changes that can take place in a residential building over time; change in technical functions, comfort, façade renovations, ...

GRADUAL CHANGE

When something will change gradually, you might design it in such a way that not much has to be altered to transform into the new function. Certain places in the cosmopolitan could develop into learning centres. As mentioned above, a learning centre does not require as much space as a school, only one floor or part of a floor might be converted. When the learning centre grows, more alterations could be made to other floors in the building.

This scenario can help to set up a series of design strategies to ensure the ease of the transformation. Gradual alterations from apartments to learning centres should be done without disturbing the other residential apartments. The architect should design the interior spaces in such a way that dust, excessive noise and vibrations could be avoided. The size of the apartments or spaces inside the apartments could correspond to the size of classrooms, minimizing the number of walls that would have to be moved during the transformations. Techniques like cabling, ventilation and heating systems should also answer to both residential and educational needs or they should be easily adaptable.

ABRUPT CHANGE

With a radical, abrupt change, for example a complete renovation, one might consider making the effort to alter more than just a few walls. In this scenario, the school could be transformed into the primary school, illustrated in Image 4.1. Disturbing other functions will not be a problem in this case. Rewiring, new flooring, moving the place of the walls would all be possible and maybe considered. However, it is still important to bear in mind the reuse of as many materials in the transformation as possible, since this could still lower the environmental impact. Designing interior walls that can be moved without damaging them, floorings that can be exchanged easily, techniques and cable that can be moved without damaging them or the surrounding materials, are design strategies that could be incorporated into the main building concept to increase the project's transformability.

REACTION OF THE PROJECT'S ARCHITECT

The architect's reaction to the scenario planning strategy was very positive. He immediately started brainstorming about other solutions and scenarios. He explained how they already do scenario planning for parking lots for their recent projects. In Brussels, an apartment building has to provide one parking spot for each apartment. This takes up a lot of space. Bogdan & Van Broeck imagine a future where the number of cars owned by residents will be lower and there will be no use for the parking lots anymore. For this reason, they do not design underground parking spaces, but rather on the ground floor. When the demand for parking spaces decreases, these areas can host a new function.

One way for the cosmopolitan to adapt to future changes, could be by adapting the interior walls. They built light infill walls so changes can easily be made. Even so, no materials in the interior would be reusable after the alterations.

The architect saw potential in the method of scenario planning. He doubted, whether this method would have been useful to convince the client of the Cosmopolitan to invest in future renovations. Since the client is a real-estate agent, he will sell the apartments to private owners after construction and thus has not interest in the future of the building. The architect did see the potential in the case of public actors or social housing companies. As they will be the owner for a longer time span, the scenario planning strategy could convince them to invest more during the first renovation to lower the costs in the next one.

4.2. KEY-MOMENT 2: STRUCTURAL DESIGN & MATERIAL – DEVELOPED DESIGN PHASE – NIBE & ECOLIZER - PETERBOS #9

As explained in chapter three, the *Ecolizer* and/or NIBE environmental classification could be interesting tools to be applied support architects when making decisions on the structural design and materials in the developed design phase. They are simplified tools based on the Lifecycle assesment of materials, that allow inexperienced users to calculate the effect of their design on the environment. These tools can indicate the environmental impact of design choices and allow the user to compare different scenarios. The following paragraphs analyse the different structural scenarios designed by the architects of 51N4E for the horizontal extension of peterbos#9.

ECOLIZER AND NIBE ENVIRONMENTAL CLASSIFICATION SYSTEM ILLUSTRATED ON PETERBOS #9

ECOLIZER

As mentioned before, the architects of *Peterbos #9* played with different options for the bearing structure of the horizontal extension. During the interview, they explained how each option led to a dead end. As mentioned before, they were not able to prove nor convince the client that one option would be better than the other. The *Ecolizer* helps to point out which option would have a smaller environmental impact than others.

For each structural scenario, the user has to indicate the amount of each material and how it was processed. These materials and processes correspond to environmental impact unit values in the *Ecolizer* database. For each structural scenario designed for Peterbos#9, the environmental impact was determined. From the plans received from the architects, the volume of each of the proposed structural element was determined. The exact calculations for the scenarios can be found in Annex 7 Table 4.3 presents the values, obtained from the calculations.¹³

Table 4.3: PRELIMINARY results obtained from using the Ecolizer

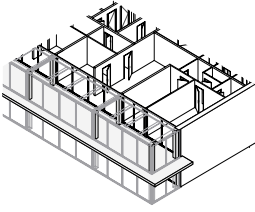
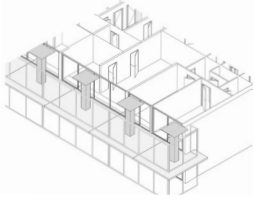
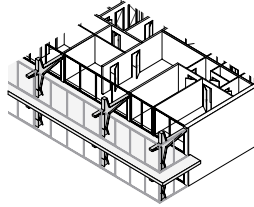
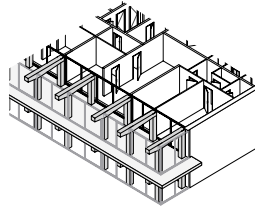
OPTION 1	OPTION 2	OPTION 3	OPTION 4
 <p>PREFABRICATED CONCRETE BEAMS & SLABS</p>	 <p>CONCRETE MUSHROOM STRUCTURE</p>	 <p>PREFABRICATED STEEL COLUMNS & CONCRETE SLABS.</p>	 <p>TIMBER BEAMS & CONCRETE COLUMNS</p>
9.217.580,72	14.770.558,70	7.684.354,53	23.466.794,43

According to the *Ecolizer*, the structure with the timber beams and concrete columns has by far the largest environmental impact. The main reason for this result is the land-use of timber.¹⁴ Moreover, a timber beam needs a larger cross-section compared to concrete in order to answer to fire safety regulations. The environmental impact of steel and concrete seemed to be closely related. The concrete mushroom structure on the other hand seemed to have a larger environmental impact. This is probably due to the dimensions of the mushroom columns compared to the more traditional concrete in option 1.

Ecolizer is an interesting tool to consult during the developed design phase. For certain materials, the tool asks for details about material itself and processing of this material (e.g. how the steel was processed, the type of steel). These are often not defined yet in this phase. Comparing these different options and processing methods could, however, guide the architects further towards making better informed decisions with regards to environmental impact.

Even though the *Ecolizer* contains basic building materials and gives a good first idea of the environmental impact of a certain design choice, it is clear from the enormous numbers and lack of specific building material options, that this tool is not meant for the building industry. For this reason, OVAM has developed the Totem tool.¹⁵ However, this tool requires very standard and detailed information, something that is not available yet in the developed design phase.

NIBE ENVIRONMENTAL CLASSIFICATION

Therefore, another interesting tool to use is the *NIBE environmental classifications system*. This system classifies building products according to their environmental impact. This table can be found in chapter two. To find the environmental class of a certain construction or product, the architect has to compare his design to a standard construction in the *NIBE* catalogue. Each standardised construction comes with graphs, indicating the different types of the construction's environmental impacts such as greenhouse gasses, human toxicity, acidification. This way the designer and client can decide for themselves which facets of the environmental impact they find most important.

Table 4.4: Nibe classification method, applied to the structural scenarios of Peterbos#9

SCENARIOS	STANDARDIZED STRUCTURE IN NIBE CATALOGUE	ENVIRONMENTAL IMPACT CLASS.
OPTION 1 PREFABRICATED CONCRETE BEAMS & SLABS	Construction apartment, 12 levels, grid 5,4m, prefabricated concrete & wideslab floor.	1B
OPTION 2 CONCRETE MUSHROOM STRUCTURE	No corresponding standardized construction	/
OPTION 3 PREFABRICATED STEEL COLUMNS & CONCRETE SLABS.	Construction apartments, 12 levels, grid 5,4m, steel & wide slab floor.	1C
OPTION 4 TIMBER BEAMS & CONCRETE COLUMNS	No corresponding standardized construction	/

Contrary to the results of the *Ecolizer*, *NIBE* claims that the concrete structure would have a lower environmental impact.

Although the *NIBE environmental classification system* is an efficient system where an architect can easily find the environmental impacts of different building products, it is not yet optimized for structural systems. The standardized structures with which the user has to compare his design are very limited and based on the standard building industry. An architect who wants to apply an unusual design, will not be able to check its environmental impact with *NIBE*. Even in the case of Peterbos#9, two out of four structural scenarios were not comparable with any of the standard structures in *NIBE*. Besides bearing structures, *NIBE* does offer a good and divers catalogue of building materials.

It is clear that both the *Ecolizer* and *NIBE environmental classification system* are not ideal when it comes to checking the environmental impact of the structural design of a building in the developed design phase. Where the *Ecolizer* needs specific details that are not decided on yet, *NIBE* neglects certain specificities all at once by comparing to standardized constructions. As already mentioned in many papers in literature, there is a need for lifecycle assessment tools that can be used during the earlier design phases.¹⁶

Because of the numerous assumptions and simplifications of both tools, the results turned out to be different. There is still no clear proof on which structural scenario has the lowest impact, since *NIBE* and the *Ecolizer* contradict each other. However, in certain scenarios, for example for the timber beams, the *Ecolizer* did point out its high environmental impact.

REACTION OF THE ARCHITECTS

The architects of 51N4E were interested in the tools, especially because they wanted to analyse their different scenarios before, but they admitted that they did not have the knowledge. They also admitted that there was never much time to do analyses like LCAs and would even be interested in hiring a consultancy office for circular building. However, in that case, they would have to find clients who would be willing to pay the extra cost.¹⁷

Therefore, the architects were particularly pleased to see there are tools available to quickly compare environmental impacts. They saw the potential of the *Ecolizer* as a verification tool of a certain design. For them it was interesting to see clear numbers and they saw a potential in proving the environmental benefit of certain scenarios towards the client. While the architects were observing the books of *NIBE* it became rapidly clear that for this tool the potential would be more in the detailed phase, where they would have to compare specific building materials such as insulation, tiles, etc.¹⁸

4.3. KEY-MOMENT 3: MATERIAL - DETAILED DESIGN PHASE – 24 GUIDELINES TO TRANSFORMABLE DESIGN - TOUR BRUNFAUT

The 24 Guidelines to transformable design can be applied in many phases of the design process. they focus on different levels. building, component and neighbourhood. Some levels will be more important than others, depending on the phase that will be analysed.¹⁹ In the case of the detailed design phase, the element level will be most appropriate. This is also the level that was assigned to this key phase in chapter three.

The following paragraphs analyse Tour Brunfaut with a method, similar to the one Ann Paduart applied in her doctoral thesis.²⁰ Depending on how the design corresponds to a certain guideline, a '+' or '-' is given. The table at the end of this chapter will show on which points the design can be improved.

Table 4.5: categories and guidelines on the element level

	 Interfaces	 Sub-components	 Composition
 Element	Reversibility Simplicity Speed	Durability Reused Compatibility	Pace-layered Independence Prefabrication
 Building	Accessibility	Demountability Reusability Extensibility	Versatility
 Neighbourhood	Clear Adaptable	Retrofitted Dimensioned Removable	Unified Multipurpose Diverse Densifiable

24 GUIDELINES TO TRANSFORMABLE DESIGN ILLUSTRATED ON TOUR BRUNFAUT

REVERSIBILITY – INTERFACES

By connecting elements with reversible connections, it will become much easier to remove elements without damaging them and allow them to be used elsewhere. Reversibility in connections can be assured by using dry connectors e.g. screws, nails, bolts. But also click-systems, e.g. Velcro or lime mortar.

In Tour Brunfaut:

FLOOR	-	The timber flooring and insulation layer in the floor are connected with reversible connections. However, Linoleum, the flooring material has to be connected with wet connections.
WALL	+	All connections in the façade panels are bolted. (<i>apart from the airtight tapes</i>)

SIMPLICITY – INTERFACES

Simplifying connections can assure that demounting components will happen more

easily, preventing the need for an expert. Working with simple and standardized tools (e.g. standard bold connections).

In Tour Brunfaut

FLOOR	+	the components are connected with simple connections like bolts.
WALL	+	Bolts and other tools are rather standard.

SPEED – INTERFACES

Allowing components to be rapidly assembled and disassembled, will encourage the client or contractor to do so. The speed of dismantling can be improved by allowing easy access to the connections, giving the component enough space to be moved, minimising the number of connection points, etc.

In Tour Brunfaut

FLOOR	+	The simple build-up of the floor, allows each element to be reached easily and rapidly. However, in the case of removal, the glued linoleum risks to be damaged.
WALL	+/-	The façade is build-up of prefabricated façade panels. This will speed up the building process. However, the façade panels themselves contain many connections, making them harder to disassemble.

DURABILITY – COMPONENTS

Components that are not useful anymore in a certain function or place, might still be useful somewhere else. In order to ensure that this component is still in a good shape when the time comes, the durability of the component should be ensured. Durable materials are for example, brick, steel beams and profiles, timber beams, etc.

In Tour Brunfaut

FLOOR	+	Linoleum floor finishing is very durable and easy to maintain. Timber and rockwool
WALL	+	Attention was paid to the durability of the façade material. Therefore, aluminium was chosen as façade material. Other materials are recyclable (timber, rockwool and gyproc).

REUSE OF EXISTING COMPONENTS – COMPONENTS

Reusing existing components will reduce building waste. Especially when reusing the components of the building you are renovating. This will also reduce cost and pollution due to transportation.

In Tour Brunfaut

FLOOR	+/-	Apart from the existing steel beams, none of the existing floor components were reused.
WALL	+/-	Apart from the existing steel frame, none of the existing façade components were reused.

COMPATIBILITY – COMPONENTS

Standard components that can be compatible with each other will allow flexibility. It will also make it easier to repair and swap elements when components are standardly available on the market. Some techniques to create standard elements are fractal grids, they can be designed with strategies like the Hendrickx-Vanwalleghem design strategy.²¹

In Tour Brunfaut

FLOOR	+ -	Because of the generality in the existing and new steel structure, each timber floor panel has the same size. The size of linoleum panels depends on the size of the rooms, this component is not compatible (<i>since it is not reusable, this is not really important</i>)
WALL	+	The façade panels are based on the grid of column in the construction and thus all have the same size, meaning there is a compatibility within the framing system.

LAYERING – COMPOSITION

In order to efficiently remove, repair or replace certain elements, they could be layered according to their functional or technical life span. Different characteristics of the layer should be taken into account (e.g. esthetical trends, technical requirements, how fast a material loses its performance) the first layers that will be outdated should be easily accessible.

In Tour Brunfaut

FLOOR	+	Technical and functional layers are divided by attaching technical layers, for example, electricity in build-up.
WALL	+	There is a physical barrier between the different layers of the wall that have different lifespans. Even though the layers are not ordered according to lifespan, each layer can easily be reached without damaging the others.

INDEPENDENCE – COMPOSITION

Being able to remove, repair or replace elements separately, without disturbing other elements can also improve the transformability. Components can be removed at the same time, increasing the speed of the dismantling process.



Image 4.2: conceptual drawing of dependant structures (left) and independent structures (middle & right)²²

In Tour Brunfaut

FLOOR	-	By gluing linoleum over the whole floor, the flooring is not independent anymore.
WALL	+	Each frame can be taken of separately.

PREFABRICATION – COMPOSITION

Prefabrication ensures quality control, uniformity of connections, decreased waste, etc.
 Prefabrication of compositions increases the assemble speed on site.

In Tour Brunfaut

FLOOR	-+	The timber floor slabs are prefabricated. The rest of the floor is laid on the construction site.
WALL	+	Each façade panel is prefabricated

CONCLUSION

Overall, Tour Brunfaut scored relatively well when evaluating it with the 24 guidelines to transformable design. The use of glued linoleum was the main material or technique that was not coherent with the tool. It decreased the reversibility, compatibility and the independence. The rest of the detailed design seemed to be correspond to the guidelines.

Table 4.6: summary of the analysis with 24 guidelines to transformable design.

	FLOOR	WALL
REVERSIBILITY	-	+
SIMPLICITY	+	-
SPEED	+	-
DURABILITY	+	+
REUSE OF EXISTING MATERIALS	+ -	+ -
COMPATIBILITY	+ -	+
LAYERING	+	+
INDEPENDENCE	-	+
PREFABRICATION	-+	+

REACTION OF ARCHITECTS

The architects at A229 seemed to find many of the guidelines quite evident. However, having them listed as a way to evaluate the building did show potential. Even though the Tour Brunfaut corresponds to many criteria of the twenty-four guidelines to transformable design, the architect admitted that many of these choices were made for practical reasons rather than sustainability. For example, simple connections and materials were chosen to simplify the already very complicated project. The durable, façade aluminium panels, were chosen for their maintenance and longer lifespan compared to other façade materials on the market. This shows that making sustainable choices are not always made with the environmental impact in mind. Maybe to convince a client it is more important to show him the practical side of the choices, for example, lower costs over time, ease of maintenance, etc.²³

This rationality and practicality of the architects at A229 became also apparent when asked about the design choices that did not correspond to the twenty-four guidelines to transformable design. They explained how the use of linoleum was matter of budget and maintenance, mostly demanded by the client. Other, more reversible, flooring alternatives, like tiles or parquet, proved to be either too expensive or hard to maintain. Reusing elements of the existing building, other than the steel bearing structure, was also not seen as an option by A229 because of the asbestos in the materials or because nothing responded to contemporary norms.²⁴

EINDNOTEN

- 1 Valery van der Linden, 'Architects' Attitudes towards Users in Design.' (26 March 2019).
- 2 Charlotte Cambier, Waldo Galle, and Niels De Temmerman, 'The Relevance of Adaptable Façade Systems: An Evaluation through Scenario Planning' (13th Conference on Advanced Building Skins, Bern, 2018).
- 3 Lourenço van Innis, 'The design process of the Cosmopolitan - interview 1', 19 November 2019.
- 4 'Basisonderwijs: 12 Procent Meer Aanmeldingen, Tekort Groeit', Bruzz, 16 March 2017, <https://www.bruzz.be/samenleving/basisonderwijs-12-procent-meer-aanmeldingen-tekort-groeit-2017-03-16>.
- 5 Aline Vergauwen, 'A Design Strategy for the Transformation of Vacant Office Buildings into Schools' (Master Thesis, Vrije Universiteit Brussel, 2011).
- 6 Bogdan & Van Broeck, 'Tender Plans - Cosmopolitan', 2015.
- 7 Lourenço van Innis, 'The design process of the Cosmopolitan - interview 1'.
- 8 Bogdan & Van Broeck, 'Tender Plans - Cosmopolitan'.
- 9 Bogdan & Van Broeck.
- 10 Lourenço van Innis, 'The design process of the Cosmopolitan - interview 1'.
- 11 Rf-Technologies, 'Handboek Basisnormen. Editie 2017' (Rf-t, 2017).
- 12 Bogdan & Van Broeck, 'Tender Plans - Cosmopolitan'.
- 13 OVAM, 'Catalogus', Ecolizer, accessed 2 June 2019, <http://ecolizer.be/catalogue/77>.
- 14 Liesbet Van Aceleyen, 'Ecolizer: Vergelijking Hout En Beton', 10 May 2019.
- 15 Liesbet Van Aceleyen.
- 16 Elke Meex et al., 'Requirements for Applying LCA-Based Environmental Impact Assessment Tools in the Early Stages of Building Design', *Building and Environment* 133 (April 2018): 228–36, <https://doi.org/10.1016/j.buildenv.2018.02.016>, <https://doi.org/10.1016/j.buildenv.2018.02.016>.
- 17 Jan Opdekamp and Ruben Janssens, 'The design process of peterbos #9 & discussion design for change assessment tools - Interview 2', 9 May 2019.
- 18 Jan Opdekamp and Ruben Janssens.
- 19 OVAM, '24 Ontwerprichtlijnen Veranderingsgericht Bouwen', 2016, <http://www.ovam.be/sites/default/files/atoms/files/24%20Ontwerprichtlijnen%20veranderingsgericht%20bouwen%28upd%29.pdf>.
- 20 Paduart, 'Re-Design for Change: A 4-Dimensional Renovation Approach towards a Dynamic and Sustainable Building Stock'.
- 21 Paduart.
- 22 OVAM, '24 Ontwerprichtlijnen Veranderingsgericht Bouwen'.
- 23 Renaud Van Espen, 'The design process of Tour Brunfaut & discussion on design for change assessment tools - Interview 2', 6 May 2019.
- 24 Renaud Van Espen.

CONCLUSION

This thesis attempts to connect the theory on design for change to practice through the use of design tools and strategies. To answer to this research goal, it attempts to shed light on the decisions, influencing factors and actors in the design process. With this knowledge, key phases in the design process are indicated, where design tools could have the largest impact to change a design project. The design tools in this research were design for change assessment tools, they support architects to make decisions that can increase the transformability of their design.

A timeline development method was established to understand how a design project unfolds over the course of its design process. Analysing the three case studies with this method, allowed to derive a variety of conclusions about the way design decisions are taken and the design process itself.

Design processes usually start with broad conceptual choices about the function of the building. In this phase, the first concept of the building is defined, but no final choices are made. This is when a design tool and strategies that can help to define functional concepts, e.g. scenario planning, will possibly have the largest influence. Thereafter, usually after the architects win a design competition, the decisions start to narrow down, the structural design, structural materials and technical concepts are chosen along. Tools that can estimate the environmental impact of a material in a quick and easy way, could help decision-making on the structural design and material. In the last phase, before the execution, the architects focus the details of the building. The most useful tools would be the ones aiding with the decisions on the type of layering, materials and connections in the build-up of a building component, e.g. 24 guidelines on transformable design.

Even though all three case studies used the same renovation method, each their design processes were very different, especially because they were renovation projects, where the design processes can become complex. The course of the process depended largely on when the information about the building could be accessed by the designers. Early access, as in Tour Brunfaut, resulted in a strong building concept on all design aspects, that was barely altered in the rest of the process. The architects who accessed the information in the later stages of the design process were obliged to redesign certain design aspects, because of budget cuts or the poor structural quality of the existing building.

The most influencing actors in all three projects, were the clients and the legislators, especially fire and energy performance legislations, as they are rather strict and don't allow many derogations. The legislators also have the ability to prevent a building of ever being constructed. Therefore, architects are obliged to follow their rules. The preferences of the client were another important actor in the design process.

They were most interested in easy maintenance, budget and aesthetics. In all three of the cases, the clients did not show an explicit interest towards decreasing the environmental impact of their building. For example, in Peterbos #9, the architects challenged themselves to design a building while taking into account its environmental impact. Supporting architects in convincing clients is an important facet to bring the theory on design for change and circular economy closer to practice, as clients will not invest in something they are not convinced of. The outcome of design tools, as illustrated in chapter four, is one way to show a client how investing in dynamic building systems could be beneficial for the future of the building and the environmental impact. However, when represented with the outcome of the tools, some architects doubted whether all types of clients would invest in the circularity of a building. The main reason to apply transformable design, besides decreasing the environmental impact, is the reduction of the costs on future renovations. If the clients are of real-estate agents, they will immediately sell the apartments to individual buyers, giving away their responsibilities on the future of the building.

Apart from scenario planning, which is not necessarily a tool that decreases environmental impact, the architects also admitted that they did not have any knowledge on the design for change assessment tools design tools. Nor did they use design tools that could support them in decreasing the environmental impact of their designs. Informing architects on the possibilities of design for change and circular building, could be an important way to connect theory and practice and decrease the environmental impact of their buildings.

FURTHER RESEARCH

Overall the timeline development method was able to provide noteworthy information on when the impact of a tool could be the most influential. As they were only based on two interviews per case study, where architects were looking back on months, even years of work, the timelines represent the events that they remembered. Discussing the preliminary timelines during the second interview, already allowed them to remember and discuss certain aspects into further detail. To analyse and represent very accurate timelines, timelines could be composed while the design is still taking place. The researcher could be present at each project meeting and keep track of the decisions and aspects that were discussed. This would create an even wider and deeper view on the design process and when the influence of a tool could be most effective.

The timelines build in this master thesis were made from the architects' point of view. To fully understand the decision making and influences in a design process, information received from different actors as clients, legislators, engineers could be used to build the timelines, making them more objective.

As the information on decisions is needed to build the timelines, they will not be able to change the analysed projects anymore. However, they could be useful to researchers as retroactive method to determine trends in the design processes of architectural offices. With these trends, new strategies could be formulated to enhance the decision-making process of architects towards better-informed design choices with regard to environmental impact and circularity. The knowledge derived from establishing different timelines could also be used to determine ideal timelines in the beginning of a project. They could explain architects in which stage they should invoke a certain tool to decrease the environmental impact or enhance the transformability of their project.

BIBLIOGRAPHY

BIBLIOGRAPHY OF CHAPTER I

- ‘België Telde Op 1 Januari 2018 11.376.070 Inwoners | Statbel’. Accessed 14 April 2019. <https://statbel.fgov.be/nl/nieuws/belgie-telde-op-1-januari-2018-11376070-inwoners>.
- Bragança, Luís, Susana M. Vieira, and Joana B. Andrade. ‘Early Stage Design Decisions: The Way to Achieve Sustainable Buildings at Lower Costs’. *The Scientific World Journal* 2014 (2014): 1–8. <https://doi.org/10.1155/2014/365364>.
- Brand, Stewart. *How Buildings Learn: What Happens after They're Built*. Viking Press, 1994.
- Chokhachian, Ata. ‘Studies on Architecture Design Procedure A Framework for Parametric Design Thinking’, n.d., 147.
- Crilly, Nathan, Anja Maier, and P John Clarkson. ‘Representing Artefacts as Media: Modelling the Relationship Between Designer Intent and Consumer Experience’. *International Journal of Design*, 2008, 14.
- Debacker, Wim, Waldo Galle, Mieke Vandenbroucke, L. Wijnants, W. C. Lam, Anne Paduart, Pieter Herthogs, and Yves De Weerd. ‘Design for Change: Development of an Assessment and Transitional Framework (Summary)’. Mechelen: OVAM, 2015. <http://www.ovam.be/sites/default/files/atoms/files/TWOL-Design-for-change.pdf>.
- Elke Meex. ‘Circular Bouwen in Vlaanderen?’ Infosession presented at the Circulair en veranderingsgericht bouwen - een nieuwe rol voor de architect?, Mechelen, 7 May 2019.
- Galle, Waldo, and Pieter Herthogs. ‘Veranderingsgericht bouwen: ontwikkeling van een evaluatie- en transitiekader: Een gemeenschappelijke taal’. OVAM, 2015. <https://vlaanderen-circulair.be>. ‘Green Deal Circulair Bouwen’. Vlaanderen Circulair. Accessed 1 June 2019. <https://vlaanderen-circulair.be/nl/onze-projecten/detail/green-deal-circulair-bouwen>.
- . ‘Open Call - Vlaanderen Circulair’. Accessed 1 June 2019. <https://vlaanderen-circulair.be/nl/aan-de-slag/open-call>.
- Lawson, Bryan. *How Designers Think: The Design Process Demystified*. 4. ed. Amsterdam: Elsevier/Architectural Press, 2006.
- Meex, Elke. ‘Early Design Support for Material Related Environmental Impact Assessment of Dwellings’. Doctoral Thesis, UHasselt, 2018. <https://uhdspace.uhasselt.be/dspace/handle/1942/27512>.
- Paduart, Anne. ‘Re-Design for Change: A 4 Dimensional Renovation Approach towards a Dynamic and Sustainable Building Stock’. Doctoral thesis, Vrije Universiteit Brussel, 2012.

P&P architectes. 'Peterbos'. p&p Architectes SPRL. Accessed 1 June 2019. <http://www.pparchitectes.com/peterbos.html>.

RIBA. 'RIBA Plan of Work'. RIBA, 2013.

BIBLIOGRAPHY OF CHAPTER 2

51N4E, and Lacaton & Vassal. 'Peterbos #9 Brochure', 12 October 2017.

A229. 'Rénovation de La Tour Brunfaut. Dossier de Candidature Be.Exemplary', 7 October 2016.

'A229 - Equipe'. A229. Accessed 1 June 2019. <https://a229.be/equipe>.

Anne Lacaton, Jean Philippe Vassal, and Frederic Druot. 'Tour Brunfaut. Definitiestudie Voor Een Rehabilitatie'. Lacaton&Vassal, March 2011.

'BOGDAN & VAN BROECK'. Accessed 1 June 2019. <https://www.bogdanvanbroeck.com/about/>.

'BOGDAN & VAN BROECK Op Instagram: "Crossing an Urban Block! | New Set of Pictures by @jeroenverrecht"', 31 May 2019. <https://www.instagram.com/p/ByIaTA0Ikvn/>.

Buyle, Matthias, Johan Braet, and Amaryllis Audenaert. 'Life Cycle Assessment in the Construction Sector: A Review'. *Renewable and Sustainable Energy Reviews* 26 (October 2013): 379–88. <https://doi.org/10.1016/j.rser.2013.05.001>.

Cambier, Charlotte, Waldo Galle, and Niels De Temmerman. 'The Relevance of Adaptable Façade Systems: An Evaluation through Scenario Planning'. Bern, 2018.

David Huber. 'Lacaton & Vassal. Game Changers'. *Metropolis*, January 2016.

Debacker, Wim, Waldo Galle, Mieke Vandenbroucke, L. Wijnants, W. C. Lam, Anne Paduart, Pieter Herthogs, and Yves De Weerd. 'Design for Change: Development of an Assessment and Transitional Framework (Summary)'. Mechelen: OVAM, 2015. <http://www.ovam.be/sites/default/files/atoms/files/TWOL-Design-for-change.pdf>.

'Dethier Architecture'. Dethier Architecture. Accessed 1 June 2019. <http://www.dethier.be/fr>.

Elke Meex. 'Circulair Bouwen in Vlaanderen?' Infosession presented at the Circulair en veranderingsgericht bouwen - een nieuwe rol voor de architect?, Mechelen, 7 May 2019.

Goedkoop, Mark, Reinout Heijungs, and Mark Huijbregts. 'ReCiPE 2008: A Life Cycle Impact Assessment Method Which Comprises Harmonised Category Indicators at the Midpoint and the Endpoint Level', May 2018, 134.

Lacaton & Vassal. 'Transformation de 530 Logements, Bâtiments G, H, I, Quartier Du Grand Parc.', 2016. <https://www.lacatonvassal.com/index.php?idp=80>.

Levasseur, Annie, Pascal Lesage, Manuele Margni, Louise Deschenes, and Réjean Samson. 'Considering Time in LCA: Dynamic LCA and Its Application to Global

Warming Impact Assessments'. *Environmental Science & Technology* 44, no. 8 (2010): 3169–3174.

'Materials Passports'. BAMB. Accessed 8 January 2019. <https://www.bamb2020.eu/topics/materials-passports/>.

Meex, Elke. 'Early Design Support for Material Related Environmental Impact Assessment of Dwellings'. Doctoral Thesis, UHasselt, 2018. <https://uhdspace.uhasselt.be/dspace/handle/1942/27512>.

Niall Patrick Walsh. 'Grand Parc Bordeaux Wins 2019 EU Prize for Contemporary Architecture - Mies van Der Rohe Award'. ArchDaily, 11 May 2019. <https://www.archdaily.com/914806/grand-parc-bordeaux-wins-2019-eu-prize-for-contemporary-architecture-mies-van-der-rohe-award>.

NIBE. *Draagconstructies*. NIBE'S Basiswerk. Milieuclassificaties Bouwproducten. 1. Bussum: NIBE research, 2011.

Opdekamp, Jan, and Ruben Janssens. The design process of Peterbos #9 - Interview 1, 6 November 2018.

OVAM. '24 Ontwerprichtlijnen Veranderingsgericht Bouwen', 2016. <http://www.ovam.be/sites/default/files/atoms/files/24%20Ontwerprichtlijnen%20veranderingsgericht%20bouwen%28upd%29.pdf>.

———. 'FAQ - Gebruik van de Totem Tool', 24 January 2019. <https://www.totem-building.be/pages/about.xhtml>.

Renaud Van Espen. The design process of Tour Brunfaut-Interview 1, 20 November 2019.

Valery van der Linden. 'Architects' Attitudes towards Users in Design.' Brussels, 26 March 2019.

'Veelgestelde Vragen - Achtergrondinformatie Ecolizer - OVAM Ecolizer'. Accessed 31 May 2019. <http://ecolizer.be/help>.

Vincent Degrune. 'The Brunfaut Tower. Presentation of the Conceptual Design Challenges of a Renovation.', 89–92. Brussels: Brussels urban development, 2014.

'What Is Materials Passports'. BAMB. Accessed 10 February 2019. <https://www.bamb2020.eu/topics/materials-passports/what/>.

BIBLIOGRAPHY OF CHAPTER 3

51N4E. 'Peterbos #9 - Presentations'. Brussels, October 2018.

A229. 'BRUNFAUT Réhabilitation et Rehausse de La Tour Brunfaut de 97 Habitations Sociales Molenbeek, 2013'. A229. Accessed 2 June 2019. <https://a229.be/post/74265830584/brunfaut-r%C3%A9habilitation-et-rehausse-de-la-tour>.

———. 'Rénovation de La Tour Brunfaut. Dossier de Candidature Be.Exemplary', 7 October 2016.

Anne Lacaton, Jean Philippe Vassal, and Frederic Druot. 'Tour Brunfaut. Definitiestudie

- Voor Een Rehabilitatie'. Lacaton&Vassal, March 2011.
- Bogdan & Van Broeck. 'Cosmopolitan - Concept Sketches', January 2014.
- . 'Cosmopolitan. Competition Proposal', January 2014.
- 'BOGDAN & VAN BROECK Op Instagram: "Crossing an Urban Block! | New Set of Pictures by @jeroenverrecht"', 31 May 2019. <https://www.instagram.com/p/ByIaTA0Ikvn/>.
- Jan Opdekamp, and Ruben Janssens. The design process of peterbos #9 & discussion design for change assessment tools - Interview 2, 9 May 2019.
- Lawson, Bryan. *How Designers Think: The Design Process Demystified*. 4. ed. Amsterdam: Elsevier/Architectural Press, 2006.
- Lourenço van Innis. The design process of the Cosmopolitan & discussion on design for change assessment tools - interview 2, 2 May 2019.
- . The design process of the Cosmopolitan - interview 1, 19 November 2019.
- Meex, Elke. 'Early Design Support for Material Related Environmental Impact Assessment of Dwellings'. Doctoral Thesis, UHasselt, 2018. <https://uhdspace.uhasselt.be/dspace/handle/1942/27512>.
- Meex, Elke, Elke Knapen, and Griet Verbeeck. 'Case Study Analysis of the Material Selection Process during Dwellig Design in Flanders', 10, n.d.
- Opdekamp, Jan, and Ruben Janssens. The design process of Peterbos #9 - Interview 1, 6 November 2018.

BIBLIOGRAPHY OF CHAPTER 4

- 'Basisonderwijs: 12 Procent Meer Aanmeldingen, Tekort Groeit'. *Bruzz*. 16 March 2017. <https://www.bruzz.be/samenleving/basisonderwijs-12-procent-meer-aanmeldingen-tekort-groeit-2017-03-16>.
- Bogdan & Van Broeck. 'Tender Plans - Cosmopolitan', 2015.
- Cambier, Charlotte, Waldo Galle, and Niels De Temmerman. 'The Relevance of Adaptable Façade Systems: An Evaluation through Scenario Planning'. Bern, 2018.
- Jan Opdekamp, and Ruben Janssens. The design process of peterbos #9 & discussion design for change assessment tools - Interview 2, 9 May 2019.
- Liesbet Van Aceleyen. 'Ecolizer: Vergelijking Hout En Beton', 10 May 2019.
- Lourenço van Innis. The design process of the Cosmopolitan - interview 1, 19 November 2019.
- Meex, Elke, Alexander Hollberg, Elke Knapen, Linda Hildebrand, and Griet Verbeeck. 'Requirements for Applying LCA-Based Environmental Impact Assessment Tools in the Early Stages of Building Design'. *Building and Environment* 133 (April 2018): 228–36. <https://doi.org/10.1016/j.buildenv.2018.02.016>.
- OVAM. '24 Ontwerprichtlijnen Veranderingsgericht Bouwen', 2016. <http://www.ovam>.

be/sites/default/files/atoms/files/24%20Ontwerprichtlijnen%20veranderingsgericht%20bouwen%28upd%29.pdf.

———. 'Catalogus'. Ecolizer. Accessed 2 June 2019. <http://ecolizer.be/catalogue/77>.

Paduart, Anne. 'Re-Design for Change: A 4 Dimensional Renovation Approach towards a Dynamic and Sustainable Building Stock'. Doctoral thesis, Vrije Universiteit Brussel, 2012.

Renaud Van Espen. The design process of Tour Brunfaut & discussion on design for change assessment tools - Interview 2, 6 May 2019.

Rf-Technologies. 'Handboek Basisnormen. Editie 2017'. Rf-t, 2017.

Valery van der Linden. 'Architects' Attitudes towards Users in Design.' Brussels, 26 March 2019.

Vergauwen, Aline. 'A Design Strategy for the Transformation of Vacant Office Buildings into Schools'. Master Thesis, Vrije Universiteit Brussel, 2011.

ANNEX

STEEL			
material/bewerking	mPt/eenheid	Hoeveelheid	environmental impact
elektrostaal (volledig gerecycleerd)	63,00 mPt/kg	2.544,70 kg	160.315,85 mPt
warm gewalst	30,00 mPt/kg	2.544,70 kg	76.340,88 mPt
gaslassen	23,00 mPt/m	2.338,58 m	53.787,29 mPt
afbanking	30,00 mPt/kg	2.544,70 kg	76.340,88 mPt
acryllak, 87,5% in water	211,00 mPt/kg	345,15 kg	72.826,16 mPt
beams in floor plate	16.172,00 mPt/m3	63,08 m3	1.020.192,83 mPt
concrete floor	16.172,00 mPt/m3	389,40 m3	6.297.376,80 mPt
wapeningsstaal beams	197,00 mPt/kg	2.252,10 kg	443.662,76 mPt
wapeningsstaal floor	197,00 mPt/kg	4.633,86 kg	912.870,42 mPt
TOTAL			9.113.713,87 mPt

Concrete columns			
material/bewerking	mPt/eenheid	Hoeveelheid	environmental impact
Concrete columns	16.172,00 mPt/m3	89,46 m3	1.446.688,90 mPt
concrete beams	16.172,00 mPt/m3	8,04 m3	130.003,47 mPt
concrete floor	16.172,00 mPt/m3	389,40 m3	6.297.376,80 mPt
beam inside floor	16.172,00 mPt/m3	12,59 m3	203.650,76 mPt
edge beam	16.172,00 mPt/m3	70,48 m3	1.139.860,78 mPt
wapeningsstaal column	197,00 mPt/kg	5.322,66 kg	1.048.563,19 mPt
wapeningsstaal beam	197,00 mPt/kg	286,99 kg	56.536,08 mPt
wapeningsstaal floor	197,00 mPt/kg	149,85 kg	29.521,30 mPt
total			10.352.201,29 mPt

timber beams + concrete columns			
material/bewerking	mPt/eenheid	Hoeveelheid	environmental impact
Timber beams (Glued laminated timber, for exterior use)	221,00 mPt/kg	59.966,28 kg	13.252.547,88 mPt
Afdanking	17,00 mPt/kg	59.966,28 kg	1.019.426,76
Concrete columns	16.172,00 mPt/m3	116,08 m3	1.877.250,16 mPt
concrete floor	16.172,00 mPt/m3	389,40 m3	6.297.376,80 mPt
beams in floor plate	16.172,00 mPt/m3	63,08 m3	1.020.192,83 mPt
wapeningsstaal column	197,00 mpt/kg	6.906,78 kg	1.360.634,91 mPt
wapening beams	197,00 mpt/kg	2.252,10 kg	443.662,76 mPt
wapeningsstaal floor	197,00 mpt/kg	4.633,86 kg	912.870,42 mPt
total			26.183.962,52 mPt

Concrete mushroom columns			
material/bewerking	mPt/eenheid	Hoeveelheid	environmental impact
Concrete columns	16.172,00 mPt/m3	301,29 m3	4.872.461,88 mPt
concrete beams	16.172,00 mPt/m3	0,00 m3	0,00 mPt
concrete floor	16.172,00 mPt/m3	343,83 m3	5.560.476,98 mPt
wapeningsstaal column	197,00 mpt/kg	17.926,76 kg	3.531.570,74 mPt
wapeningsstaal floor	197,00 mpt/kg	4.091,62 kg	806.049,11 mPt
total			14.770.558,70 mPt

COMPARISON			
STEEL	TIMBER BEAMS + CONCRETE COLUMNS	CONCRETE	CONCRETE MUSHROOMS
9.113.713,87	26.183.962,52	10.352.201,29	14.770.558,70

TECHNICS

INHABITED CONSTRUCTION

MATERIAL

STRUCTURAL DESIGN

FUNCTION

PREDESIGN

simple intervention - find one solution for similar renovations.

INPUT

- Individual quality of life
- Spatial comfort
- Technical equipment
- Sustainable energy management
- Shared public and collective space

INFLUENCING FACTORS

Technical autonomy
Budgetary and material
Looking for feasible solutions
Example projects by Lacoan & Vissal, where the concept of the addition of the second facade was successfully implemented.

OUTCOME

Second facade as winter gardens
Winter garden can serve as thermal buffer
Gives extra living space.

INPUT DEVELOPED DESIGN PHASE

Problems that had to be solved
Fire safety
Dusting with results of building analysis

INFLUENCING FACTORS

South and north facades are in bad condition, resulting in the thermal walls had become bearing over time, so making openings in them was not possible any more.
The function of the winter gardens stayed present
Ventilators on the south facade were eliminated

OUTCOME

Not that many people in terms of function
However, continuing research on the function, chosen in pre-design phase, resulted in implications on the other aspects. Energy performance, the thermal buffer principle was not taken into account (influence on material)

INPUT

Proving that winter gardens serve as thermal buffer, showing that the insulation indoors could phase.

INFLUENCING FACTORS

Energy regulations: E-Reg (Belgian regulation) only allows static calculations. To prove that the winter gardens are not a burden on the structure, the regulation needed. This method was not accepted by the regulation

OUTCOME

Can the concrete structure still be circular?
Together with the engineer they designed a connection that could be taken apart. However, due to budget reasons this track was not taken into account (influence on material)

DETAILED DESIGN PHASE

Detailing, how will the building layers be composed?
wintergardens are not counted as thermal buffers, due to the static calculation method of Belgian energy regulations.

INPUT

Communication to the inhabitants
Practical concerns
experience of Lacoan & Vissal with the same type of renovation.
Planning of the renovation steps is introduced

INFLUENCING FACTORS

Heating systems have to be replaced
Replacement of heating system while people are still living in the building.
Connections are made during the construction of the second facade.

OUTCOME

DETAILED TIMELINE

PETERBOS #9

BY STINE AND LACONVASSAL

The process is sketched into progress based parameters, horizontal direction. In the vertical direction, the process is sketched into design aspects, with arrows indicating the design phases. The thickness of the arrow is proportional to the amount of research done, leading to a decision.

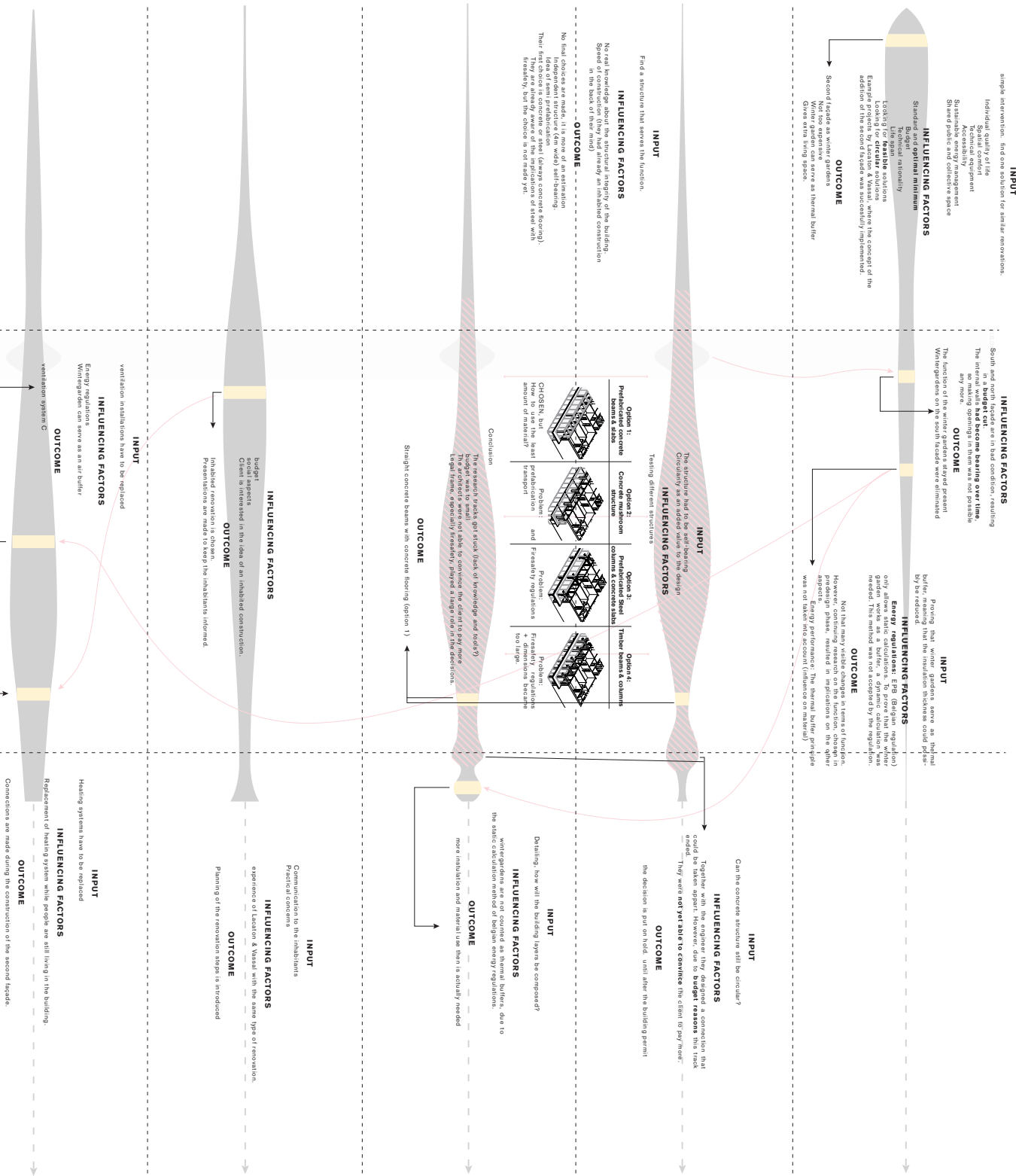

Smooth transition
a decision is made and worked out

Abrupt decision
usually it means that an idea or aspect is dropped

Decision moment

Clearly connected research

Influences

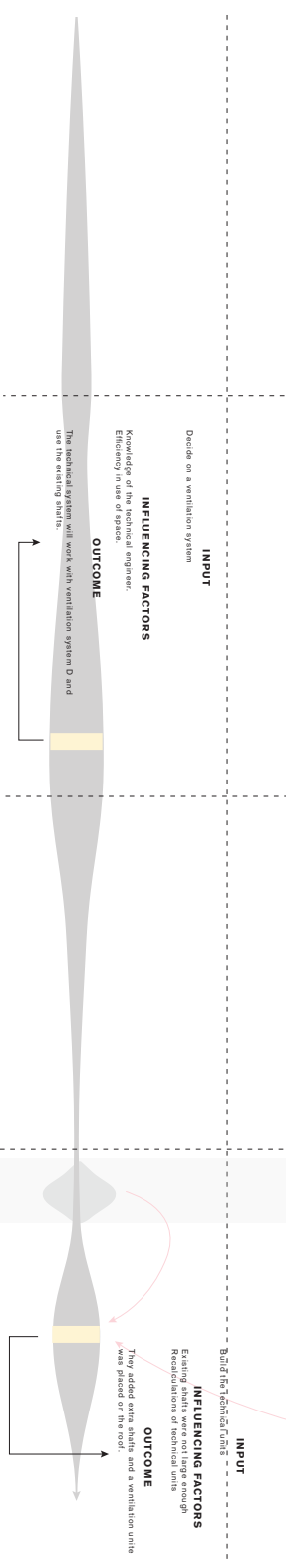
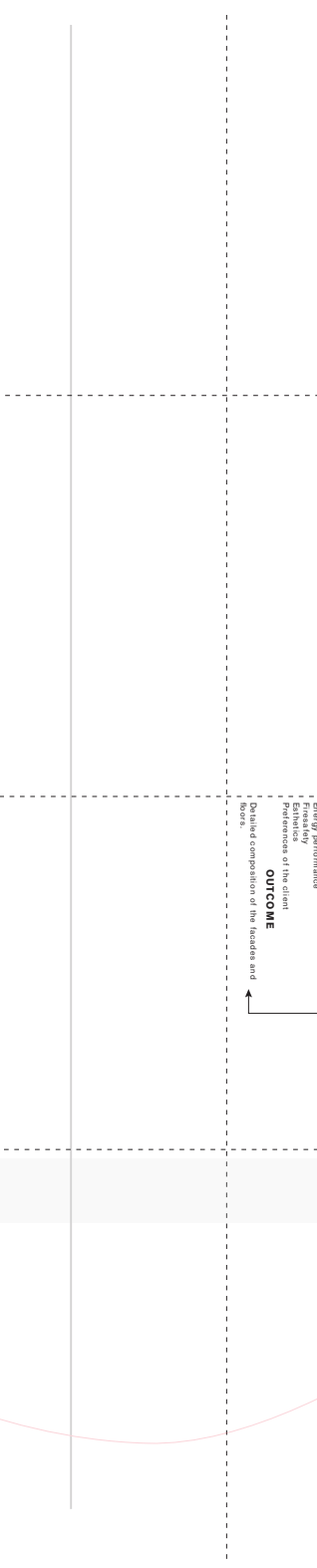
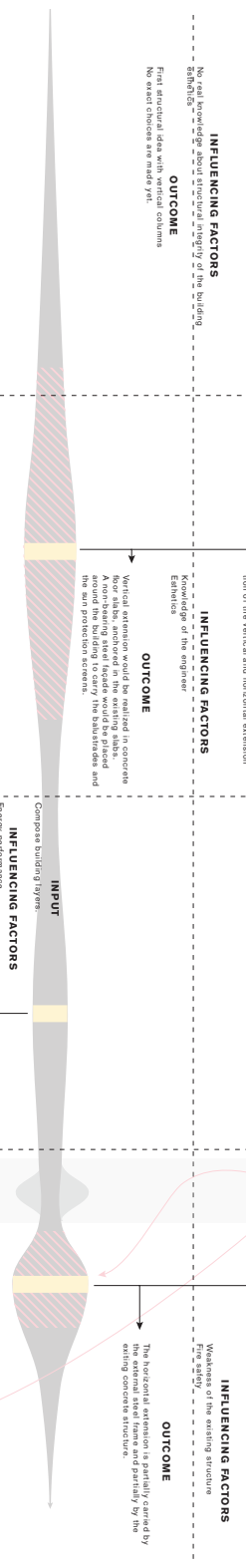
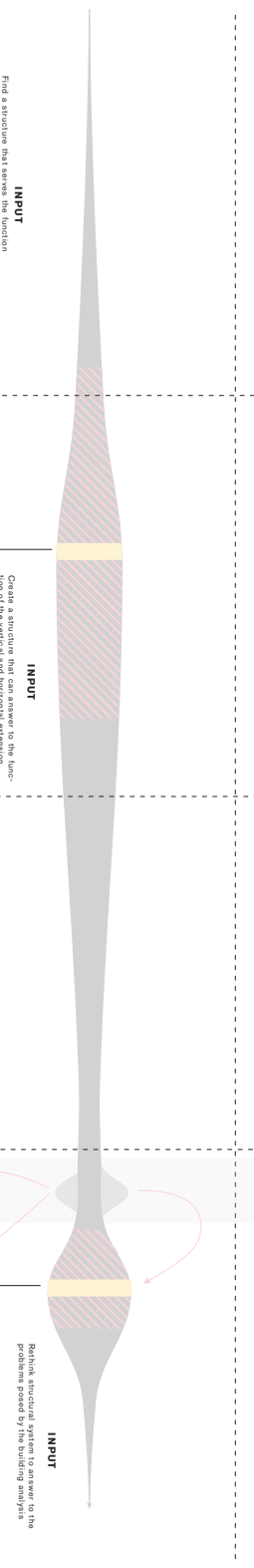
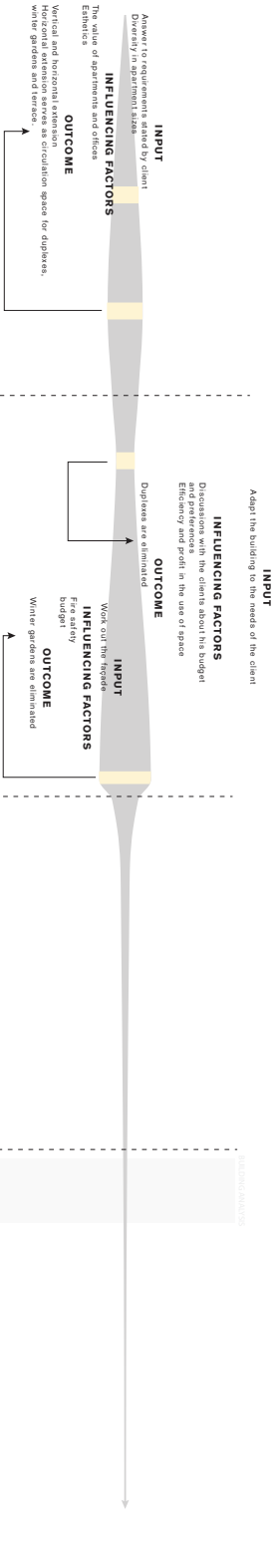

TIMELINE
COSMOPOLITAN
BY ROODAN & VAN BROECK

The process is divided into progress based phases: Uninformed decision, In the vertical dimension, the process is classified into design aspects, design decisions, design choices, design slices, The thickness of the arrow is more revealing about the design slices. The thickness of the arrow indicates the amount of research done, leading to a decision.

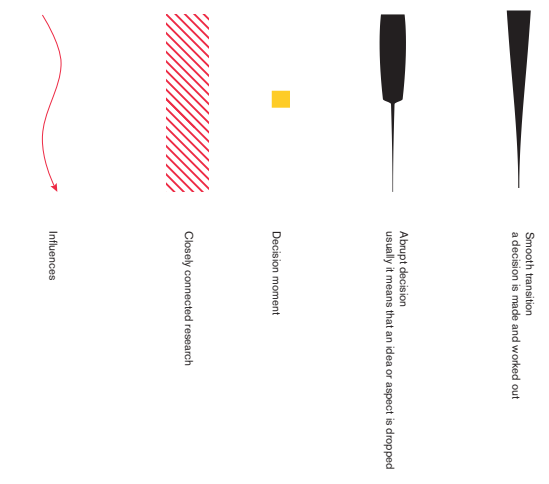

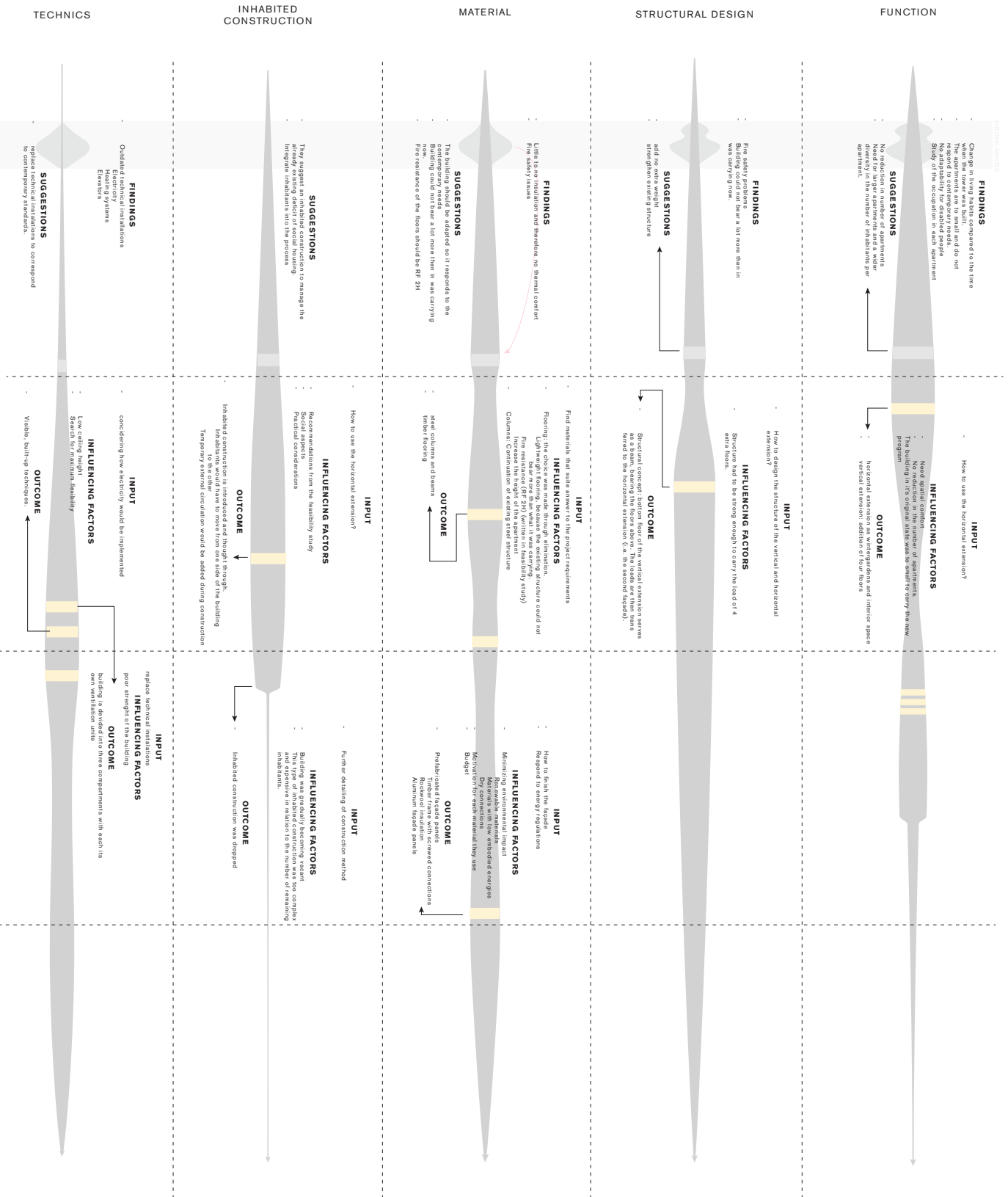

DETAILED TIMELINE
BRUNFAUT TOWER
BY A239 AND DREHNER ARCHITECTS

The process is divided into progress based parameters, horizontal direction. In the vertical direction, the process is divided into design aspects, with a focus on the development of the design process. The thickness of the arrow shows varying amounts of design phase. The thickness of the arrow indicates the amount of research done, testing or a decision.



Smooth transition
a decision is made and worked out



Abrupt decision
usually it means that an idea or aspect is dropped



Decision moment



suggestion



Closely connected research



Influences

* see description